

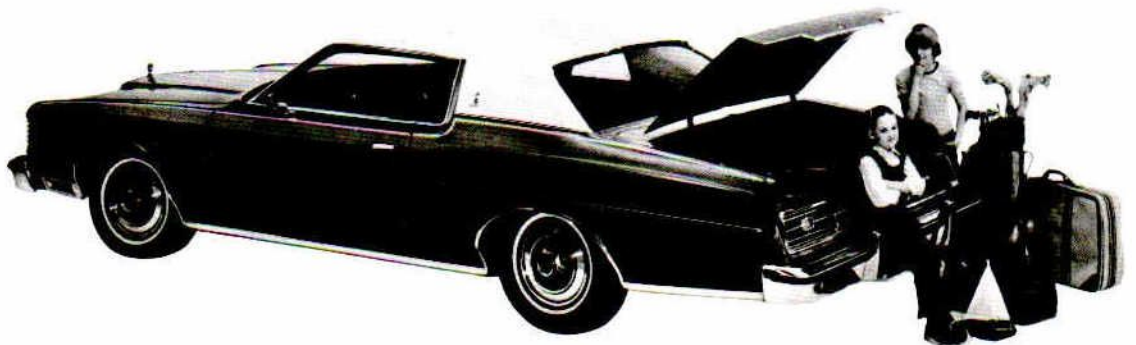

FORD...

**The closer you look,
the better we look.**

Your close look will show why Ford merits your selection. Sleek styling. Doors that open easily, close solidly. Precision fitting there, at the hood and deck lid. A smooth, glossy finish. And superb tailoring inside.



FORD INDEX

1974 FORD MODELS

Complete Model Line-Up.....	2
CUSTOM 500.....	4
GALAXIE 500.....	5
LTD.....	6
LTD BROUGHAM.....	7
RANCH WAGON.....	8
COUNTRY SEDAN.....	9
LTD WAGON.....	10
SQUIRE WAGON.....	10

BODY FEATURES

Ash Tray, Lighted.....	17
Body Construction.....	15
Body—Insulation/Sound Package.....	16
Body Mounts.....	15
Body Sealing Material.....	15
Door Handles.....	17
Guard Rails, Steel..... See Section A, p. 6	
Headlight Adjustment.....	17
Heating.....	16
Hood Release, Inside.....	17
Instrument Panel.....	17
Luggage Compartment.....	17
Marker Lights, Side.....	17
Paint Process, Six-Step..... See Section A, p. 5	
Reinforced Roof..... See Section A, p. 6	
Restraint System, 3-Point Occupant..... See Section A, p. 6	
Seats.....	16
Ventilation, Power.....	16
Starter Interlock and Warning Light Buzzer..... See Section A, p. 6	
Windows.....	17
Windshield Wipers/Washers.....	17

CHASSIS FEATURES

Brakes.....	14
Brakes, Disc..... See Section A, p. 2	
Brake System..... See Section A, p. 2	
Bumper System Energy-Absorbing..... See Section A, p. 2, 3	
Frame.....	14
Shock Absorbers..... See Section A, p. 4	
Solid State Ignition..... See Section A, p. 5	
Steering Column, Energy- Absorbing..... See Section A, p. 2	
Steering Column, Locking..... See Section A, p. 1	
Steering, Power.....	14

Steering Wheels.....	14
Suspension, Front.....	14
Suspension, Rear.....	15
Suspension Specifications.....	15

COLOR AND TRIM.....26, 27

MARKET DATA..... 3

OPTIONS

Complete Listing.....	21, 22
Anti-Theft Alarm System.....	20
Brougham Luxury Group.....	20
Bumper Group, Deluxe.....	18
Convenience Group.....	18
Cornering Lamps, Front.....	19
Defroster, Electric Rear Window.....	19
Fingertip Speed Control.....	19
Load-Adjuster, Automatic.....	20
Metallic-Glow Paint.....	19
Power Mini-Vent and Side Windows.....	18
SelectAire Air Conditioning With Automatic Temperature Control.....	18
Seat Back Release, Automatic.....	19
Seat, Split Bench w/Manual Passenger Recliner.....	19
Sunroof, Power-Operated.....	19
AM/FM Stereo Radio with Tape Player.....	18
Traction-Lok Differential Axle.....	20
Trailer Hitch Platform, Load-Equalizing.....	21
Trailer Towing Packages.....	21
Wheel Cover, Base.....	20
Wheel Cover, Deluxe.....	20
Windshield Wipers, Interval.....	19

SPECIFICATIONS

Body Dimensions.....	25
Brake Specifications.....	24
Curb Weights.....	24
Engine/Axle Ratio Selections.....	23
Steering Specifications.....	24
Tires, Standard Availability.....	23
Wheel Specifications.....	24

STANDARD EQUIPMENT..... 13

STATION WAGON FEATURES.....11, 12

FORD 14 MODELS

TWO-DOOR HARDTOPS (3)

	Sales Code No.	Body Code No.
Galaxie 500	58	65F
LTD	62	65H
LTD Brougham	68	65K



FOUR-DOOR PILLARED HARDTOPS (4)

	Sales Code No.	Body Code No.
Custom 500	53	53D
Galaxie 500	54	53F
LTD	63	53H
LTD Brougham	66	53K



FOUR-DOOR HARDTOPS (3)

	Sales Code No.	Body Code No.
Galaxie 500	56	57F
LTD	64	57H
LTD Brougham	67	57K



STATION WAGONS (4)

	Sales Code No.	Body Code No.
Custom 500 Ranch Wagon (6-passenger)	72	71D
Country Sedan (6-passenger)	74	71F
Country Squire (6-passenger)	76	71H
LTD Wagon (6-passenger)	76	71H





FORD...

**The closer you look,
the better we look.**

Your close look will show why Ford merits your selection. Sleek styling. Doors that open easily, close solidly. Precision fitting there, at the hood and deck lid. A smooth, glossy finish. And superb tailoring inside.



FORD CUSTOM 500 SERIES



MODEL

Custom 500 4-Door Pillared Hardtop

MAJOR STANDARD FEATURES

SALES
NUMBER
53

EXTERIOR

- Long 121" wheelbase, wide-stance . . . front 64.2" . . . rear 64.4" contribute to Ford's famous riding comfort
- Argent-painted egg-crate grille with bright surround molding
- Bright wheelip moldings
- Bright drip moldings
- Frameless door glass with thin "B" pillar
- New energy-absorbing front and rear bumper system . . . meets 1974 Federal Standards . . . 5 mph front and rear impacts . . . 3 mph corner impacts
- Recessed pull-out door handles
- Ventless side glass
- Dual headlamps
- Dual separated rear side marker lights . . . body color
- Outside left-hand mirror
- Concealed 2-speed electric windshield wipers with wiper-mounted washer jets
- Bright metal hub caps
- Integral parking lamps and front side marker lights in front fender extensions
- "Custom 500" "C" pillar script

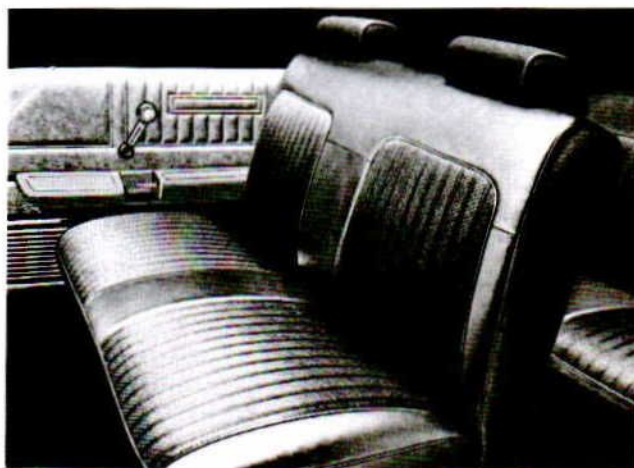

INTERIOR

- Cloth-and-vinyl seat trim
- All-vinyl door trim panels color-keyed to the interior . . . full-length padded armrests
- Instrument panel features molded impact pad on top surface and extending part-way down the front
- Black camera case appliqué with partial simulated-woodtone appliqué on passenger side of instrument panel
- "Custom 500" script on right-hand instrument panel appliqué.
- Color-keyed loop-pile carpeting
- Dome light in center of roof headliner
- High-visibility, 12-inch wide inside rearview mirror with "double-jointed" mounting bracket
- Two rear-seat ash trays
- Large bin-type glove box . . . 676 cubic-inch capacity
- Lighted ash tray . . . cigar lighter
- Suspended brake and accelerator pedals
- Turn signal with lane-changing feature
- Color-keyed steering wheel and column
- Padded sun visors, left and right
- Bright aluminum door scuff plates
- Partial luggage compartment mat

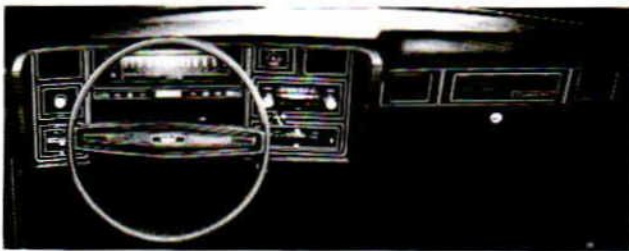

FUNCTIONAL

- 351 CID 2V V-8 engine
- SelectShift Cruise-O-Matic transmission
- Power steering
- Power front disc brakes
- Power ventilation system
- MagicAire heater-defroster with 3-speed blower
- Reversible keys with one-step keyless locking
- Aluminized muffler
- 22-gallon fuel tank refill (approx.)
- G78 x 15 belted bias ply BSW tires
- Inside hood release

See page B-13 for complete listing of standard equipment.

FORD GALAXIE 500 SERIES



MODELS

	SALES NUMBER
4-Door Pillared Hardtop	54
2-Door Hardtop	58
4-Door Hardtop	56



MAJOR STANDARD FEATURES

EXTERIOR

The Galaxie 500 Series shares many features with the Custom 500 model. Mutual styling features include:

- Bright wheelip moldings
- New energy-absorbing front and rear bumper system . . . meets 1974 Federal Standards . . . 5 mph front and rear impacts . . . 3 mph corner impacts
- Integral parking lamps and front side marker lights
- Ventless side glass
- Recessed pull-out door handles

Additional features include:

- Bright bodyside moldings
- Chrome-plated grille with unique crest
- Bright belt moldings
- Galaxie 500 script on right rear deck lid
- Galaxie 500 script on "C" pillars
- Chrome-plated lower back panel appliqué
- Bright deck lid and taillamp surround moldings
- Bright hood rear molding

INTERIOR

In addition to or in place of features on the Custom 500:

- Unique, higher level, cloth-and-vinyl pleated upholstery
- All-vinyl door trim panels with simulated woodtone inserts
- Galaxie 500 script on instrument panel appliqué
- Simulated-woodgrain appliqué on center cluster of instrument panel

FUNCTIONAL

In addition to or in place of features on the Custom 500:

- Additional sound-deadening material (See page B-16)
- Dual note horn

The Galaxie 500 Series shares these features with the Custom model:

- 351 CID 2V V-8 engine
- SelectShift Cruise-O-Matic transmission

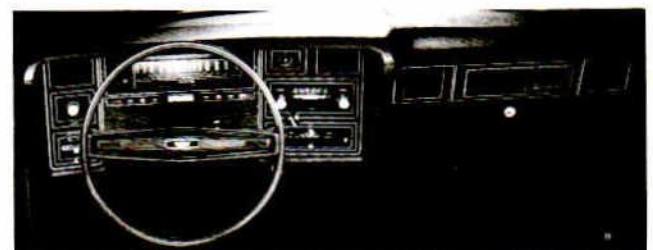
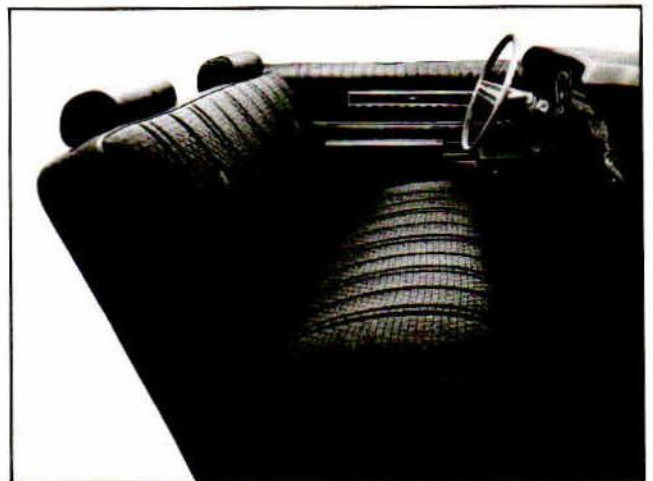

- Power steering
- Power front disc brakes
- Power ventilation system
- MagicAire heater-defroster with 3-speed blower
- Reversible keys with one-step keyless locking

See page B-13 for complete listing of standard equipment.

FORD LTD SERIES



MODELS

- 2-Door Hardtop
- 4-Door Pillared Hardtop
- 4-Door Hardtop

SALES NUMBER
62
63
64

MAJOR STANDARD FEATURES

EXTERIOR

In addition to or in place of the features on the Galaxie 500 Series:

- High-series grille, chrome-plated
- "LTD" hood ornament
- Rocker panel moldings with front and rear extensions
- High-series integral parking lamps and front side marker lights
- Unique LTD "C" pillar ornament
- Vinyl insert bodyside moldings
- Reflective lower back panel appliqué

INTERIOR

In addition to or in place of the features on the Galaxie 500 Series:

- Luxury cloth-and-vinyl trim, higher level all-vinyl door trim panels with simulated woodgrain inserts and LTD crests
- Cut-pile carpeting (14 oz.)
- Deluxe 2-spoke steering wheel
- Full simulated woodgrain appliqué on instrument panel
- "LTD" letters on instrument panel appliqué
- Self-regulating electric clock (illuminated)
- Glove box and luggage compartment lights
- Full-width luggage compartment mat
- Bright pedal pads

FUNCTIONAL

LTD shares many features with the Galaxie 500, including:

- 351 CID 2V 8-cylinder engine

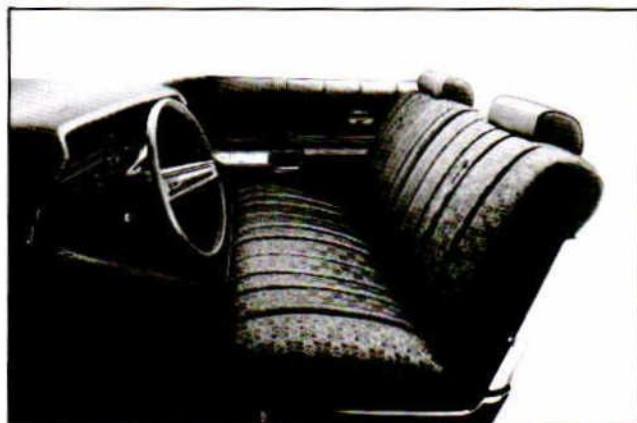

- SelectShift Cruise-O-Matic transmission
- Power steering
- Power front disc brakes
- Dual note horn

LTD features include:

- HR78 x 15 steel-belted radial ply BSW tires
- LTD sound package (See page B-16)

See page B-13 for complete listing of standard equipment.

LTD BROUGHAM SERIES



MODELS

- 2-Door Hardtop
- 4-Door Pillared Hardtop
- 4-Door Hardtop

SALES NUMBER
68
66
67

MAJOR STANDARD FEATURES

EXTERIOR

The LTD Brougham Series shares many features with the LTD Series. Mutual styling features include:

- "LTD" hood ornament
- High-series grille, chrome-plated
- Rocker panel moldings with front and rear extensions
- Vinyl insert bodyside moldings

In addition to or in place of features on the LTD Series:

- Standard vinyl roof (See page B-26 for color availability)
- "Brougham" letters under "C" pillar ornament
- Wheel covers

INTERIOR

In addition to or in place of the features on the LTD Series:

- Flight bench seat with fold-down center armrest and bright metal seat side shields
- Auxiliary ash tray in right front armrest
- Luxurious knit cloth seat trims
- Color-keyed deluxe seat and shoulder belts
- Door trim panels with "Brougham" script and cut-pile carpeting on lower portion of trim panel
- Front-door courtesy lamps
- Courtesy lights also operated by rear doors (4-door models)
- Automatic seat back release (2-door models)

FUNCTIONAL

The LTD Brougham Series incorporates the many features of all the other Series, including:

- 351 CID 2V V-8 engine
- SelectShift Cruise-O-Matic transmission

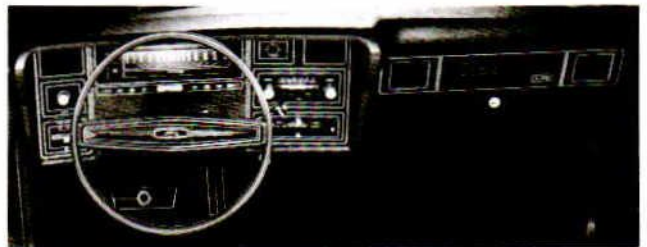

- Power steering
- Power front disc brakes
- HR78 x 15 steel-belted radial ply BSW tires
- Dual note horn

See page B-13 for complete listing of standard equipment.

FORD RANCH WAGON



MODEL

Custom 500 Ranch Wagon

SALES
NUMBER

72

MAJOR STANDARD FEATURES

CUSTOM 500 RANCH WAGON

In addition to or in place of features on the Custom 500 Pillared Hardtop, the Custom 500 Ranch Wagon offers:

EXTERIOR

- 225.2" overall length
- Bright quarter window moldings
- Bright "FORD" block letters on center of tailgate
- Vertical taillamp design with integral back-up lights
- Bright "Ranch Wagon" script on lower quarter panels

INTERIOR

- Attractive all-vinyl trim
- Fold-down second seat, providing a load floor length of 92.4" with tailgate up . . . 113.9" with tailgate down . . . 94.6 cubic feet of cargo volume
- Load floor painted with long-wearing vinyl-impregnated paint, color-keyed to the interior
- Lockable storage compartment under load floor . . . adds 9.1 cubic feet of storage space on 6-passenger models and 5.4 cubic feet on models with dual-facing rear seats

FUNCTIONAL

The Custom 500 Ranch Wagon shares many features with the Custom 500 model. Mutual features include:

- 351 CID 2V V-8 engine
- Power steering
- SelectShift Cruise-O-Matic transmission
- Power ventilation
- Power front disc brakes

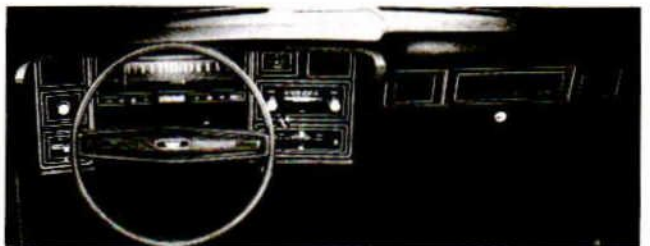
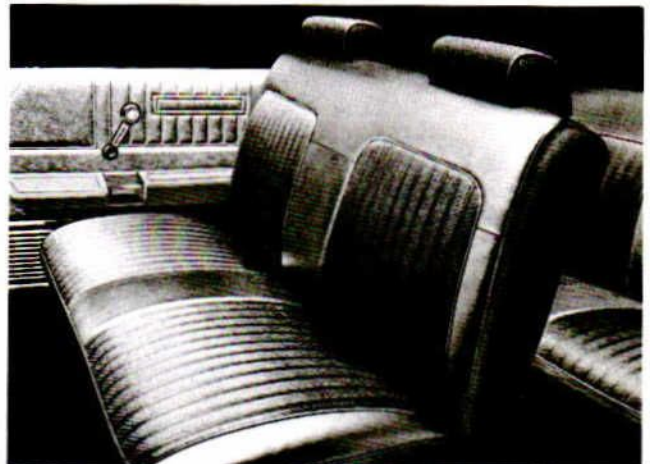

Additional features include:

- Three-Way Magic Doorgate
- Power tailgate window
- Spare tire extractor
- Station Wagon suspension (higher rate springs and large diameter shock absorbers)
- J78 x 15 belted bias ply BSW tires with 6.5" wheel rims

See page B-13 for a complete list of standard equipment.

FORD COUNTRY SEDAN



MODEL

Galaxie 500 Country Sedan

SALES
NUMBER

74

MAJOR STANDARD FEATURES COUNTRY SEDAN

EXTERIOR

The Galaxie 500 Country Sedan shares many features with the Custom 500 Ranch Wagon. Some of the mutual features include:

- 225.2" overall length
- Bright quarter window moldings
- Bright "FORD" block letters on center of tailgate
- Vertical taillamp design with integral back-up lights

In addition to or in place of features on the Custom 500 Ranch Wagon:

- Chrome-plated grille with unique crest
- Bright bodyside moldings
- Bright door belt moldings
- Bright hood rear molding
- Bright "Country Sedan" script on lower quarter panels

INTERIOR

The Country Sedan shares the following features with the Custom 500 Ranch Wagon:

- Fold-down second seat, providing a long load floor length of 92.4" with tailgate up . . . 113.9" with tailgate down . . . 94.6 cubic feet of cargo volume
- Load floor painted with long-wearing vinyl-impregnated paint, color-keyed to the interior
- Lockable storage compartment under load floor . . . adds 9.1 cubic feet of storage space on 6-passenger models and 5.4 cubic feet on models with dual-facing rear seats

Additional features include:

- All-vinyl seat trim in vertically pleated sew pattern
- Higher level front and rear door trim panels with simulated woodgrain appliqué
- Rich simulated woodgrain appliqué on instrument panel with Galaxie 500 script
- Simulated woodgrain appliqué on center cluster of instrument panel

FUNCTIONAL

The Country Sedan shares the following features with the Custom 500 Ranch Wagon:

- 351 CID 2V V-8 engine

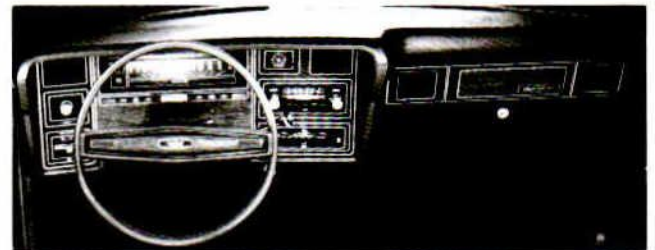
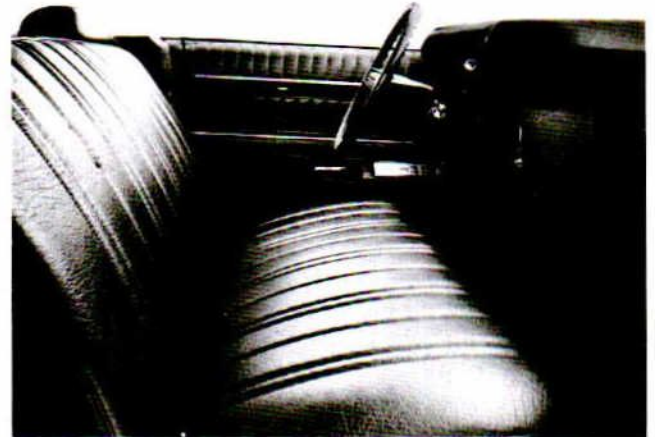

- Power steering
 - SelectShift Cruise-O-Matic transmission
 - Power ventilation
 - Power front disc brakes
 - Three-Way Magic Doorgate
 - Power tailgate window
 - Spare tire extractor
 - Station Wagon suspension (higher rate springs and large diameter shock absorbers)
 - J78 x 15 belted bias ply BSW tires with 6.5" wheel rims
- Additional features include:
- Sound package (See page B-16)
 - Dual note horn

See page B-13 for a complete list of standard equipment.

FORD LTD AND SQUIRE WAGONS



COUNTRY SQUIRE



MODELS

LTD Wagon
Country Squire

SALES
NUMBER
76
76

MAJOR STANDARD FEATURES

LTD WAGON

EXTERIOR

With the exception of exterior ornamentation, the LTD Wagon is basically the same as the Country Squire, and has the following features:

- Unique LTD hood ornament
- High-series chrome-plated grille
- Vinyl-insert bodyside moldings
- Rocker panel moldings with front and rear extensions
- LTD front fender ornaments
- Bright "FORD" block letters on lower right of tailgate . . . "LTD" ornament on center of tailgate

INTERIOR

The LTD Wagon shares all the features of the Country Squire, which are in addition to or in place of features on the Country Sedan:

- Full simulated woodgrain instrument panel appliqué
- Cut-pile carpeting
- "LTD" letters on instrument panel appliqué
- Electric clock in instrument panel (illuminated)
- Deluxe 2-spoke steering wheel
- Luxury all-vinyl interior trim . . . all-vinyl door panels with rich simulated woodgrain inserts and LTD crests
- Glove box light . . . cargo light on rear window header
- Bright pedal pads

FUNCTIONAL

The LTD Wagon shares all the features of the Country Sedan.

Additional features include:

- JR78 x 15 steel-belted radial ply BSW tires
- 400 CID 2V V-8 engine
- Solid-State Ignition
- LTD sound package

EXTERIOR

The Country Squire shares the following with the LTD Wagon:

- Unique LTD hood ornament
- High series chrome-plated grille
- Bright "FORD" block letters on lower right of tailgate . . . "LTD" ornament on center of tailgate

Additional features include:

- Vinyl-clad aluminum side rails with simulated woodgrain finish
- Simulated dark-walnut wood panels
- Bright "Country Squire" script on lower quarter panels
- Wheel covers



INTERIOR

The Country Squire shares all the features listed for the LTD Wagon including:

- Full simulated woodgrain instrument panel appliqué
- Color-keyed cut-pile carpeting
- "LTD" letters on instrument panel appliqué
- Electric clock in instrument panel (illuminated)
- Deluxe 2-spoke steering wheel
- Luxury all-vinyl interior trim . . . all-vinyl door panels with rich simulated woodgrain inserts and LTD crests
- Glove box light . . . cargo light on rear window header
- Bright pedal pads

FUNCTIONAL

The Country Squire shares all the features of the LTD Wagon, including:

- Power front disc brakes
- Power steering
- SelectShift Cruise-O-Matic transmission
- JR78 x 15 steel-belted radial ply BSW tires
- LTD sound package
- 400 CID 2V V-8 engine
- Solid-State Ignition
- Three-Way Magic Doorgate
- Power Tailgate Window
- Spare Tire Extractor

FORD STATION WAGON FEATURES

Again in 1974, Ford continues to be the Wagonmaster of the industry by providing utility, riding comfort, durability, and outstanding features for the wagon buyer. The following pages list some of these features. See the Options Section for additional items available on Ford Wagons.



SQUIRE LUXURY GROUP OPTION

Tasteful luxury and convenience are available to the LTD Wagon or Country Squire buyer with the new Squire Luxury Group Option. This option offers comfortable split bench seats with manual passenger recliner, super-soft tan Corinthian grain trim with a vertical pillowed sew style and horseshoe-shaped accent stripe, door trim panels with super-soft vinyl inserts, 25-oz. cut-pile carpeting in passenger compartment, deluxe cargo area with: lockable side stowage compartment, padded quarter trim panels and carpeted cargo area. The Convenience Group is included in the Squire Luxury Group Option, along with the tailgate window washer, and color-keyed deluxe seat and shoulder belts. See options listing on page B-21 for contents. Also included are deluxe bumper group, cigar lighters in rear door armrests, rear-door courtesy lamp switches and increased sound-deadening materials.

A Squire Brougham Option is also available for LTD Wagon or Country Squire buyers—see page B-22 for the contents of this option.



SPARE TIRE EXTRACTOR

A simple but effective spare tire extractor is standard on all Ford Wagons. It provides a convenient method of removing the spare tire from the wheel well in the right rear quarter panel. The extractor consists of a plastic sling fastened at the front of the spare tire well with a handle at the rear. The sling is underneath the tire and the handle is held by a clip in the well. To remove the tire, the hold-down wing nut and jack base are detached and the handle is disconnected from its retaining clip. Pulling up and to the left on the handle then lifts the tire out of the wheel well onto the load floor, almost effortlessly.

DURAWEAWE VINYL

This all-new Ford fabrics material is available as an option with the 1974 LTD Wagon or Country Squire. The knit

vinyl gives the appearance of a fine luxury cloth plus the durable and cleanable characteristics associated with vinyl. DuraWeave, a breathable vinyl, is available in a choice of three colors: blue, green and saddle. The addition of this new vinyl material gives LTD Wagon and Country Squire owners an expanded selection of attractive luxury interior trims.

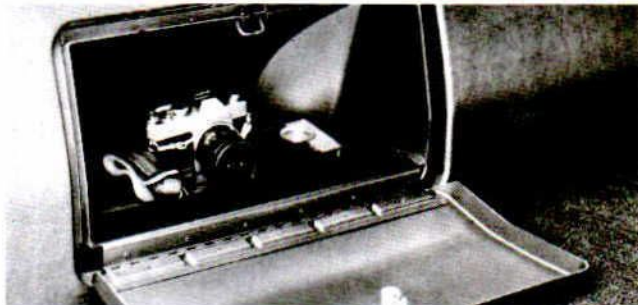

LOCKABLE SIDE STOWAGE COMPARTMENT WITH CARPETED CARGO AREA

This option features a large compartment in the left rear quarter panel that provides nearly two cubic feet of lockable storage space. Included with this option is a foam-backed and color-keyed, load floor carpet. The carpet can easily be folded for access to optional dual-facing rear seats.

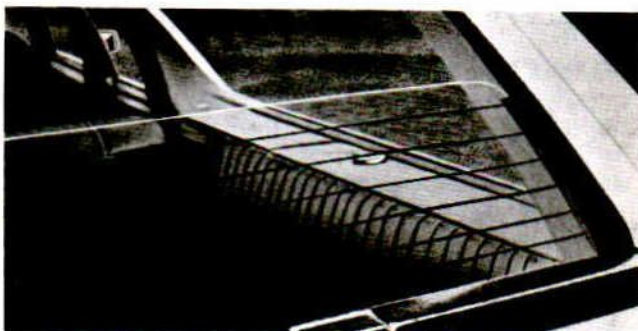
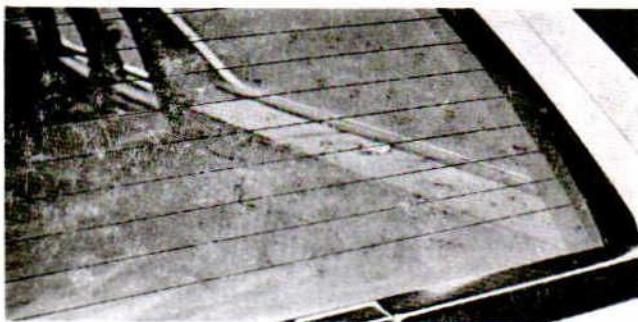

TAILGATE WINDOW WASHER

This handy option was redesigned in 1973 to improve its reliability, durability, capacity and ease of maintenance. The washer/wiper mechanism is hidden inside the tailgate door. To operate the washer, the driver lowers the tailgate window and then pushes the window switch to start the washing cycle. When the switch is pushed, a tube fills with washing fluid. After four to six seconds, the window automatically begins to rise. As the window glass passes the washer tube, fluid is sprayed through tiny holes in the front of the tube onto the glass, and the facing edge of the tube wipes the window clean. Releasing the switch stops the washing cycle. The tailgate window washer is included with the Squire Luxury Group Option.

FORD STATION WAGON FEATURES

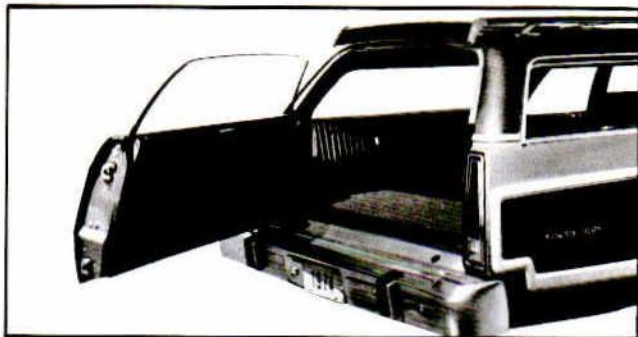

THREE-WAY MAGIC DOORGATE

Ford's famous three-way doorgate is a proven design feature that contributes to Ford's leadership in the wagon industry. The Magic Doorgate folds down like a tailgate or swings open like a door, with the window up or down. A safety interlock system requires that the glass be lowered before the door can be used as a tailgate. A safety lock button prevents accidental opening of the doorgate. When the button is depressed, the door can be opened only with the key or the optional electric-power tailgate lock. For 1974, the convenient electric power tailgate lock, which is operated by a button on the driver's or the right front passenger's armrest, is available as part of the Convenience Group, as well as being included in the electric-power door lock option for all doors. A power-operated tailgate window is standard on all wagon models.

LOAD COMPARTMENT

In the load compartment, one easy motion folds the second seat into the floor and converts the rear compartment to a flat floor. Dual-facing rear seats also fold flat into the floor. An under-the-floor, lockable storage compartment is standard on all wagons.

Load floor panels are textured-steel, covered with an attractive scuff- and scratch-resistant vinyl-base paint. The station wagon cargo volume is 94.6 cubic feet, plus under-floor capacity of 9.1 cubic feet on 6-passenger models and 5.4 cubic feet with optional dual-facing rear seats.

DUAL-FACING REAR SEATS

These optional seats, a Ford exclusive, offer additional seating for two passengers. When not in use, the seats can fold down easily for extra cargo space when needed.

ELECTRIC REAR-WINDOW DEFROSTER

This "Better Idea" helps keep the tailgate backlite frost-free and will melt snow and frost, up to $\frac{1}{8}$ -inch of ice, in minutes. The heating unit consists of a silver-filled, ceramic, high-resistance, printed electrical circuit, silk-screened onto the inside of the backlite. While visible as a series of $\frac{1}{16}$ -inch wide horizontal lines across the backlite, the unit does not interfere with the driver's rear vision due to wide spacing between lines.

The unit has a high-wattage output per square inch of window surface, which helps defog the glass and melt frost and snow quickly. An on-and-off switch is integrated with the heater controls and a reminder light indicates when the unit is on. A 70-Amp alternator is also included.

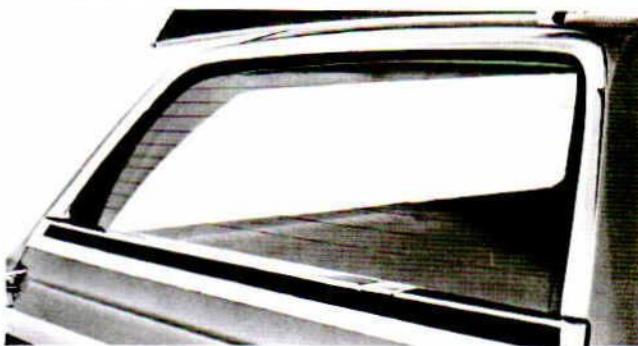

RECREATION TABLE

This versatile option is the ideal way to occupy children's time while traveling.

It is attached between the rear seats of the optional dual-facing rear seats and provides a flat surface for eating snacks, writing or game playing. Included is a set of magnetic checkers which stay in place on the metal checkerboard in the center of the table. The table top has recesses to hold cups, pencils or crayons. A raised edge around the top surface prevents objects from rolling off. When not in use, the table can be removed, folded and stored under the rear seats, or in the optional lockable side stowage compartment.

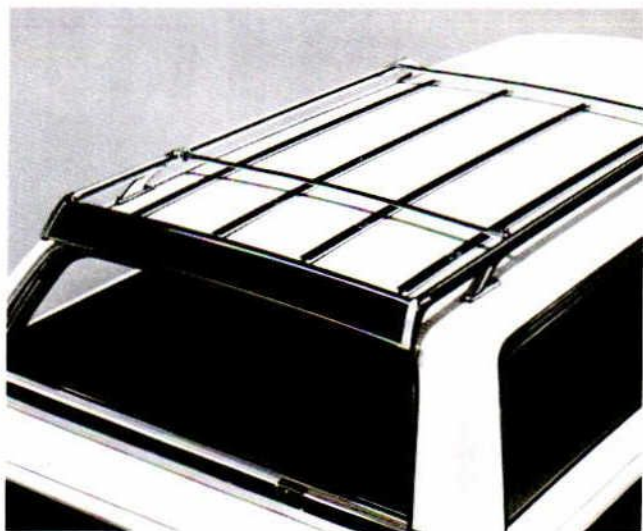

DELUXE LUGGAGE RACK

The deluxe luggage rack has simulated woodgrain trim with an adjustable end rail which adapts to different sized loads for secure roof-top station wagon hauling.

The luggage rack includes a built-in air deflector, which directs an air stream over the rear window to help prevent dirt deposits from accumulating.

FORD STANDARD EQUIPMENT

In addition to the standard features listed, Ford also includes as standard equipment the many Ford Lifeguard Design Safety Features listed on page ii.

EXTERIOR

	Custom 500	Galaxie 500	Ford LTD	LTD Brougham	Custom 500 R.W.	Country Sedan	LTD Wagon	Country Squire
GRILLE: Bright argent.....	X	—	—	—	X	—	—	—
Chrome-plated.....	—	X	—	—	—	X	—	—
Chrome-plated, high-series.....	—	—	X	X	—	—	X	X
LIGHTS: Dual headlights, backup, rear side marker, integral parking and front side marker.....	X	X	X	X	X	X	X	X
TAILLIGHTS: twin-bar (horizontal).....	X	X	X	X	—	—	—	—
Two (vertical).....	—	—	—	—	X	X	X	X
MOLDINGS: Bright decklid and taillight surround moldings.....	—	X	X	X	—	—	—	—
Bright wheelip moldings.....	X	X	X	X	X	X	X	—
Bright hood rear molding.....	—	X	X	X	—	X	X	X
Bright drip moldings.....	X	X	X	X	X	X	X	X
Bright rocker panel moldings with front and rear extensions.....	—	—	X	X	—	—	X	—
Bright quarter window moldings.....	—	—	—	—	X	X	X	X
Bright bodyside moldings.....	—	X	—	—	—	X	—	—
Bright belt moldings.....	—	X	X	X	—	X	X	X
Vinyl insert bodyside moldings.....	—	—	X	X	—	—	X	—
BRIGHT HUB CAPS	X	X	X	—	X	X	X	—
WHEEL COVERS	—	—	—	X	—	—	—	—
ORNAMENTATION: Galaxie 500 script on rear decklid and "C" pillars.....	—	X	—	—	—	—	—	—
Custom 500 script on "C" pillar.....	X	—	—	—	—	—	—	—
Galaxie 500 crest on grille.....	—	X	—	—	—	X	—	—
"LTD" ornament on hood.....	—	—	X	X	—	—	X	X
Unique LTD ornaments on "C" pillars.....	—	—	X	X	—	—	—	—
Unique LTD rear reflective appliqué.....	—	—	X	X	—	—	—	—
Unique Brougham ornaments on "C" pillars.....	—	—	—	X	—	—	—	—
Bright "Ranch Wagon" script on lower quarter panels.....	—	—	—	—	X	—	—	—
Bright "Country Sedan" script on lower quarter panels.....	—	—	—	—	—	X	—	—
Bright "Country Squire" script on lower quarter panels.....	—	—	—	—	—	—	—	X
Vinyl-clad aluminum simulated wood rails with simulated walnut paneling.....	—	—	—	—	—	—	—	X
LTD ornament on fender.....	—	—	—	—	—	—	X	—
VINYL ROOF	—	—	—	X	—	—	—	—

INTERIOR

SEATS: Front, safety-padded, energy-absorbing backs, conventional bench.....	X	X	X	—	X	X	X	X
Front, flight bench with fold-down center armrest.....	—	—	—	X	—	—	—	—
ARMRESTS: Full-length energy-absorbing, safety-type, front and rear.....	X	X	X	X	X	X	X	X
ASH TRAYS: Front in instrument panel (illuminated) with cigar lighter.....	X	X	X	X	X	X	X	X
Rear, in rear-door armrests (4-doors); in rear of front-door armrests (2-doors).....	X	X	X	X	X	X	X	X
Front, in right armrest.....	—	—	—	X	—	—	(a)	(a)
BELTS, COLOR-KEYED, DELUXE	—	—	—	X	—	—	(a)	(a)
CARPETING: Loop-pile.....	X	X	—	—	X	X	—	—
Cut-pile.....	—	—	X	X	—	—	X	X
CLOCK, ELECTRIC: Self-regulating, illuminated.....	—	—	X	X	—	—	X	X
DOORS: Door checks, front and rear; Door latches, Safety-Yoke type.....	X	X	X	X	X	X	X	X
INSTRUMENT PANEL: Glove box lock, twist opening, bin-type.....	X	X	X	X	X	X	X	X
Illuminated glove box.....	—	—	X	X	—	—	X	X
Woodtone appliqué on instrument panel, full.....	—	—	X	X	—	—	X	X
Black camera case appliqué on panel with partial woodtone finish on passenger side.....	X	X	—	—	X	X	—	—
Woodtone appliqué on center cluster of instrument panel.....	—	X	—	—	—	X	—	—
MIRROR: Inside rearview, 12" wide, double-jointed mounting bracket.....	X	X	X	X	X	X	X	X
LIGHTS: Courtesy dome, front-door switches.....	X	X	X	X	X	X	X	X
Rear door courtesy switches and front-door lamps.....	—	—	—	X	—	—	(a)	(a)
On rear window header.....	—	—	—	—	—	—	X	X
In trunk.....	—	—	X	X	—	—	—	—
SEAT BACK RELEASE, AUTOMATIC: 2-Door.....	—	—	—	X	—	—	—	—
STORAGE COMPARTMENT—BELOW FLOOR with lock.....	—	—	—	—	X	X	X	X
TURN SIGNALS WITH LANE-CHANGING FEATURE	X	X	X	X	X	X	X	X

FUNCTIONAL

BRAKES: Dual-braking system, power front disc.....	X	X	X	X	X	X	X	X
ENGINE: 351 CID 2V V-8.....	X	X	X	X	X	X	—	—
400 CID 2V V-8.....	—	—	—	—	—	—	X	X
HAZARD FLASHER: Switch on steering column.....	X	X	X	X	X	X	X	X
HEATER-DEFROSTER: MagicAire, blend-air type with 3-speed blower.....	X	X	X	X	X	X	X	X
HOOD RELEASE, INSIDE	X	X	X	X	X	X	X	X
HORN, DUAL-NOTE	—	X	X	X	—	X	X	X
MUFFLER: Stainless steel and aluminized components.....	X	X	X	X	X	X	X	X
POWER VENTILATION SYSTEM	X	X	X	X	X	X	X	X
SPARE TIRE EXTRACTOR	—	—	—	—	X	X	X	X
STEERING, POWER	X	X	X	X	X	X	X	X
THREE-WAY MAGIC DOOR-GATE WITH POWER TAILGATE WINDOW	—	—	—	—	X	X	X	X
TRANSMISSION: SelectShift Cruise-O-Matic (3-speed automatic).....	X	X	X	X	X	X	X	X
WINDSHIELD WIPERS, 2-speed electric with wiper-mounted washer jets.....	X	X	X	X	X	X	X	X

(a) With Brougham Option, Squire Luxury Group

FORD FEATURES

CHASSIS FEATURES



FRAME

The Ford torque box frame is designed to substantially reduce road shocks, thereby providing a smooth, comfortable ride. The torque box perimeter frame also features an energy-absorbing front section. Features of this design are:

An outer frame brace which increases angular impact protection and acts as an energy-absorbing member.

A front frame crossmember located in a position to increase the effective collapse length and energy-absorbing characteristics of the frame.

Reinforced front torque boxes to help reduce steering column displacement on front impact.

A tubular-design number four crossmember to increase strength and reduce transmission of vibration to the body.

Body mounts are positioned ahead of and behind the passengers, and they form a bridge that separates the body from the frame and minimizes noise and vibration.

BRAKES

All models in the Ford Series feature power front disc brakes. See Section A, page 2 for additional brake information.

STEERING WHEELS

Steering wheels are semi-oval in shape, which improves ease of entrance for the driver and, at the same time, provides a good view of the instrument cluster.

The standard two-spoke wheels have the horn-blowing contact in the spokes. Pressure applied on the top surface of the spokes, on either side of the center medallion, makes contact between a pair of metal strip switches under the vinyl covering and causes the horn to blow.

POWER STEERING

Power steering is standard on all 1974 Fords. The exclusive Ford Motor Company "Better Idea" power steering pump with "fluidic control" works when it is needed at low speeds for turning or parking, while, at highway speeds, the pump literally "coasts," without drawing valuable horsepower from the engine. Integral with the "Magic Circle" steering gear, other features of this unit include:

An integral control valve and steering gear design provides instant response to wheel movement.

A built-in low-restriction control valve allows the wheels to return to center position after making a turn.

A torsion bar element in the steering shaft provides driver "feel" of road.

An overall steering ratio of 22.2:1 provides fast, responsive steering.

See page B-24 for steering specifications.

FRONT SUSPENSION

Ford's independent front suspension uses a short- and long-arm front suspension to maintain a non-scrubbing contact with the road surface. Springs and shock absorbers are calibrated to match the weight/ride requirements of each application, depending on the car model, engine and optional equipment. Front suspension features include:

Left and right axial struts stabilize the lower arms and are attached to the frame through rubber bushings to eliminate metal-to-metal contact.

The compliant rubber bushings reduce the amount of vibration and noise transmitted to the passenger area and allow the wheels to move slightly toward the rear when hitting a bump. This controlled rear movement soaks up part of the initial road shock before it reaches the passenger area.

A link-type, rubber-bushed stabilizer bar, connecting the right- and left-hand front lower suspension arms, helps prevent excessive lean when cornering.

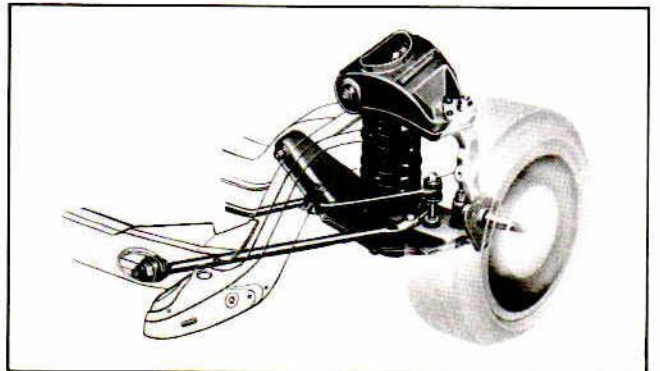

FORD FEATURES

FORD SUSPENSION SPECIFICATIONS

FRONT

Type.....Independent with Ball Joints and Drag Strut Springs*.....Coil, Rubber-Isolated Shock Absorbers*:Hydraulic, Telescopic Vertical Mount Stabilizer.....Link-Type, Rubber-Bushed Steering Knuckle..Integral Spindle and Spindle Support Wheel Bearings.....Opposed Taper Rollers

REAR

Type.....Three-Link, Rubber-Cushioned Springs*.....Coil Rubber-Isolated, Top and Bottom Shock Absorbers* : Hydraulic, Telescopic, Angle Mount Track Bar.....Rubber-Isolated

*Springs with a higher rate than those used on passenger cars and large diameter shock absorbers are standard equipment on Station Wagon models.

REAR SUSPENSION

The 1974 Ford uses a coil spring type rear suspension which includes a track bar between the axle housing and the frame. Like the front suspension, this system features rubber bushings at all pivot points to help eliminate noise and vibration. Features of the system include:

- Three longitudinal arms, two below the axle and a shorter arm above the axle, to control the position of the rear axle assembly and absorb braking and acceleration forces.
- Coil springs which ride in deep, rubber-bushed caps in the frame and are seated on the axle.
- Shock absorbers mounted at an angle to help provide additional side stability and control.
- The track bar location on the axle has been repositioned and a new bushing is fitted at the frame mounting to help improve directional stability.

BODY FEATURES

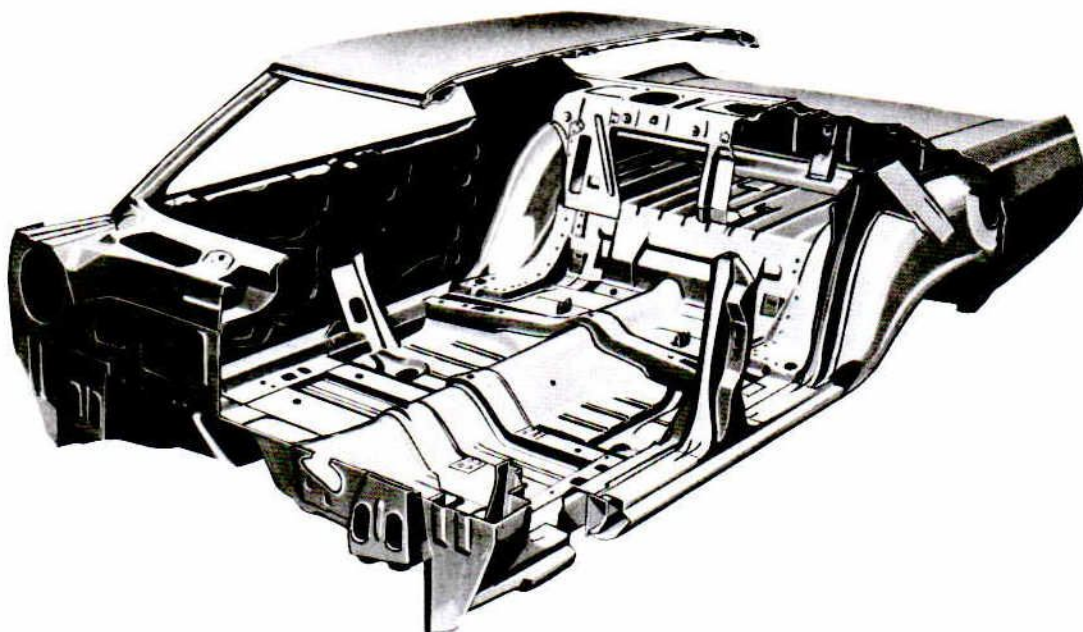

BODY CONSTRUCTION

The 1974 Ford bodies and torque box frames are designed to work together to reduce road shock, noise and vibration and the amount being transmitted to the passenger compartment. Features that help make Ford bodies quiet and strong are:

A rigid body construction coupled with the compliant mounting to the torque box frame results in substantial insulation of the passengers from noise, vibration and harshness.

Heavy sheet metal crossmembers in front seat and rear sill areas and stamped-in stiffeners add strength to the floor panel.

A reinforced, double-panel construction rocker panel, which is further strengthened by a U-channel section, acts as a secondary frame support to the body.

Cowl ventilation air inlets at the top sides—directly below the windshield, permit structural continuity to be built into the cowl top and down the side pillars.

All center pillars are manufactured from heavy-gauge steel. Additional body reinforcements in the station wagon body provide added rigidity.

BODY MOUNTS

Ford's rubber body mounts prevent metal-to-metal contact between the body and frame, thereby arresting much of the noise, vibration and harshness before it enters the passenger compartment. The tapered design of the mounts tune out many road vibrations and provide a quiet ride.

BODY SEALING MATERIAL

Joint sealers and special anti-squeak and sealing devices are used in the 1974 Fords for a comfortable, quiet ride. Special sealing features include:

Special plastic sealing material applied to exposed spot-welded body panel seams and joints. Vinyl plastic sealer used at the drip rails and rear deck trough.

Windshields and backlites sealed with butyl tape.

Special pads, grommets, seals and plug buttons are used to guard against water, dust and drafts.

Heat-curing sealer applied to all other panel seams and joints.

FORD FEATURES

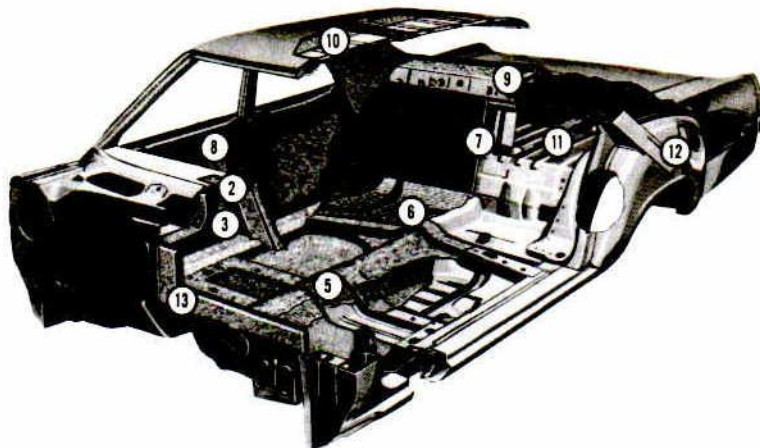

BODY INSULATION/SOUND PACKAGE

Ford's exceptionally quiet ride is, in part, the result of its use of specially selected—and engineered materials which surround the passenger compartment and form a barrier, reducing external noise (and temperature extremes as well).

1. Mastic adhesive is spotted between the inner and outer panels of the hood. Galaxie 500, LTD and LTD Brougham models use a fiberglass sound-absorber.
2. The dash panel is covered with a one-inch thick, vinyl coated, textile fiber pad.
3. The lower center portion of the instrument panel has a one-inch thick textile fiber pad.
4. The cowl is covered with a ¾-inch textile fiber pad.
5. A molded assembly of carpeting and jute and a textile fiber pad cover the front floor area. On Galaxie 500, LTD and LTD Brougham models, a heavy mastic deadener extends from the toe board to under the front seats. The LTD and LTD Brougham have additional insulation in the front floor area.
6. A molded assembly of carpeting and jute is used in the rear floor area. Galaxie 500, LTD and LTD Brougham models use an additional mastic under the carpet assembly and the rear seat.
7. The panel between the rear seat back and the luggage compartment is covered with a mastic board, plus a fiber pad on LTD and LTD Brougham models.
8. A sound-absorbing coating is sprayed on the inner surface of the outer door quarter panels.
9. Textile fiber padding covers the full-width under the package tray cover. Mastic and padding are used on LTD and LTD Brougham models.
10. The underside of the roof and the inside of the roof pillars, except on wagons, are covered with a textile fiber pad.
11. Sound-deadener is sprayed on the underside of the luggage compartment floor. A mastic adhesive is applied to the inside of the deck lid.
12. Tire splash areas of the rear wheelhousings are sprayed with a sound-deadener. Station wagon models also have an asphalt-felt deadener covering the inside surface of the wheelhousing, mastic and aluminum foil over the load floor, and an insulation pad next to the dual-facing seats.
13. LTD and LTD Brougham feature additional insulation between the engine and passenger compartment.
14. A Super Sound Package is included in the Luxury Brougham and Luxury Squire Options. Additional insulating material is utilized in the following areas: cowl side trim panels, quarter trim panels, door trim panels, front floor carpet underlay, rear floor pan, roof rails and quarter wheel houses.

HEATING

Ford's MagicAire heater and defroster has a large heater core designed to provide fast warm-up and more efficient defrosting.

A powerful three-speed blower supplements the heating system. Its motor is located outside the passenger compartment for quiet operation.

POWER VENTILATION

A Power Ventilation System is standard on all 1974 Fords. This feature includes two (four with air conditioning) registers on the instrument panel. When the operator places the heater control selector in the vent position, outside air is forced into the passenger compartment through the two (four with air conditioning) instrument panel registers and circulates through the interior of the car, providing fresh air with the windows up. Air flow may be increased by using higher fan speeds. The fan operates whenever the heater selector control is in the "Vent" position, providing air flow even when the vehicle is stopped. Moving the selector control from the "Vent" position to the "Off" position automatically turns off the fan. On sedans, the system utilizes air outlet openings beneath the rear seat, which allow air to flow back into the trunk compartment, then back through the inner body quarter panels and out through a pressure relief valve in the door lock pillar. The design of the valve is "one way" to prevent reverse flow of the air back into the passenger compartment. The Power Ventilation System is on a demand basis and will not operate unless the driver initiates the action noted above.

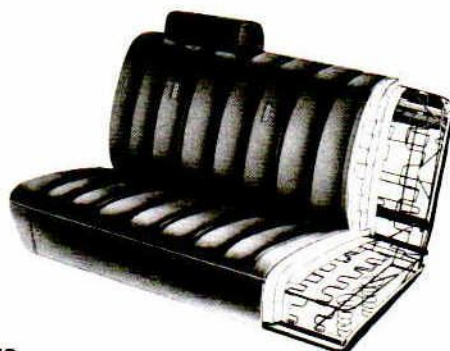

SEATS

Bench seats are standard for all Ford models. The seat frame members are of a box section and channel design. Main springs are pre-formed for comfortable support over the entire cushion and seat back. Front seat cushions include a 2½"-thick molded urethane pad, in addition to the seat cover padding, for extra seating comfort. Heavy burlap covers the springs and protects the thick foam padding.

FORD FEATURES

Front seat tracks are arched to change the angle of the seat back as the seat is adjusted forward or rearward. As the seat is moved forward, the seat back becomes more upright. Standard on all LTD Brougham models are new low-back flight bench seats. These luxurious front seats feature a wide, plush, fold-down center armrest for extra convenience and comfort.

DOOR HANDLES

Ford's exterior handles are pull-out type, recessed in the door surface. They are encased in a bright metal frame.

One-step locking is standard on all side doors. The doors may be locked from the outside by simply depressing the inside door lock control knob, and then closing the door. With recessed door handles, there is no need to depress an external pushbutton for locking or opening is not required.

The inside door handle is formed as an integral part of the armrest. The handle is a "fingertip slimline" type and actuates the door latch when pulled outward with the fingertips. The design provides protection against accidental opening by passengers. Front doors incorporate an over-ride feature which allows the door, when locked, to be opened from the inside without raising the lock button.



WINDSHIELD WIPERS/WASHERS

Concealed windshield wipers are standard on the 1974 Ford. The hood panel extends rearward and upward to cover the wiper blades and arms in the parked position. The bottom edge of the windshield extends downward for wiper blade parking.

The left wiper arm is articulated to improve the wiper pattern. The wipers are driven by a powerful two-speed electric motor.

Windshield washer jets are mounted to the wiper arm. The washer nozzle is located halfway up the wiper arm and sprays the washer fluid behind the blade on the up-stroke and ahead of the blade on the down-stroke, enabling the last wiper stroke to wipe away the previous application of fluid. This design helps reduce the problems of overshoot and under-shoot, and disperses the fluid over the entire sweep area of the blade. An 80-ounce washer reservoir is included.

WINDOWS

All models feature ventless side glass with a tube-in-shoe system used to position the windows. All windows, except windshields, are high-strength, impact-resistant, heat-tempered glass.

The thin windshields feature a .030-inch vinyl sheet sandwiched between two sheets of high-strength, impact-resistant glass.

All models utilize "Pocketless" weatherstripping that shapes itself to the glass, providing a large contact area that prevents water and air surface noise from entering the passenger compartment.

HEADLIGHT ADJUSTMENT

Ford headlights are all adjustable through screwdriver access holes without having to remove frames or bezels, providing for easy adjustment.

SIDE MARKER LIGHTS

Front side marker lights are integral with parking lamps in front fender extensions. Dual, separated rear side marker lights are located in the quarter panels.

LUGGAGE COMPARTMENT

Both two- and four-door models have 19.0 cubic feet of luggage compartment capacity. A "three-point" spare tire hold-down is used to wedge the spare tire to the trunk floor and hold it securely in position. Fender liners are used on the LTD and LTD Brougham models to seal off the rear fender interior panels. Other models use a "spackle" finish on the interior fender panels. LTD and LTD Brougham models also include a full-width mat, while Custom 500 and Galaxie 500 models include a partial mat.

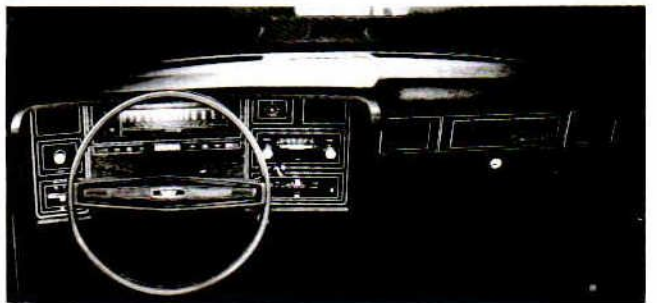

INSTRUMENT PANEL

The 1974 Ford instrument panel is designed for the convenience of driver and passengers. The horizontal speedometer and fuel gauge at the top center of the instrument cluster can be easily viewed through the steering wheel.

Directly below are the turn signal lights, warning lights and shifting dial (PRNDL), arranged in a single, horizontal row for easy reading. The headlight switch is located on the left center of the cluster and a horizontally controlled windshield wiper switch is directly below the headlight switch. The wiper switch features a push control for activating the wiper-mounted washer jets.

The radio and heater/optional air conditioning controls are at the right of the cluster, where they can be viewed and adjusted by both the driver and front passengers. The large bin-type glove box has 676 cubic-inch capacity and features a twist-open latch which can be locked. A large lighted ash tray and cigar lighter are below the heater controls, accessible to all front-seat passengers.

The Custom 500 instrument panel has black camera case finish with a partial simulated woodgrain appliqué on the passenger side. On Galaxie 500 models, the center cluster appliqué is also simulated woodgrain and on the LTD and LTD Brougham series, there is full simulated woodgrain appliqué.

INSIDE HOOD RELEASE

This anti-theft measure is standard on all 1974 Fords. The release handle is below the left side of the instrument panel. Pulling the lever partially opens the hood. This permits access to an outside safety latch, which must be released before the hood can be opened fully.

LIGHTED ASH TRAY

The large instrument panel ash tray is located below the heater controls, readily accessible to all front-seat occupants. The ash tray is also lighted, enabling occupants to easily locate the ash tray while driving in hours of darkness.

FORD OPTIONS

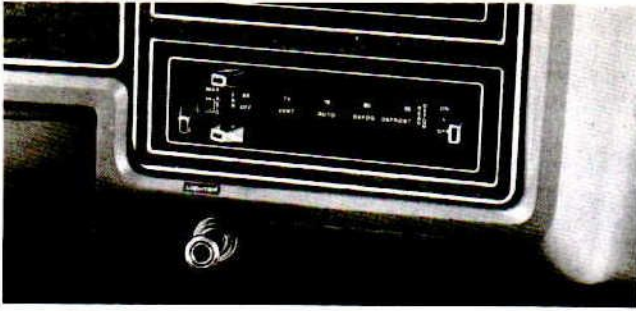

SELECTAIRE CONDITIONER WITH AUTOMATIC TEMPERATURE CONTROL

This comfort option incorporates a heater/air conditioning system that features a fast initial cool-down rate.

The system utilizes a suction-throttling valve to regulate the evaporator temperature. A magnetic clutch constantly drives the compressor, instead of cycling it to regulate the cooling. As a result, the evaporator is always cold, permitting uniform temperatures out of registers and faster response to temperature control changes. All air passes through the evaporator, providing maximum dehumidification.

Four registers on the instrument panel are positioned to insure more complete circulation. Controls are not complicated. The top control lever selects the desired air temperature and the bottom control lever can be placed in five positions: OFF, VENT, AUTO, DEFOG and DEFROST.

To operate the automatic temperature control, select the desired temperature with the top control lever. The bottom control lever must then be placed in the "AUTO" position. Blower speeds can be adjusted by the lever on the left side of the control panel. The option also includes a "MAX" blower override feature designed to allow the driver to cool the car faster than if the automatic control "HIGH" or "LOW" blower speed is used. Once the desired temperature is reached, the blower control lever can be returned to the automatic "HIGH" or "LOW" position and the selected temperature will be maintained.

SelectAire Air Conditioning with manually operated controls is also available. (See owner's manual)

AM/FM STEREO RADIO WITH TAPE PLAYER

A complete entertainment/sound system, the AM/FM stereo radio with tape player, offers three modes of operation, AM, FM and tape. Four speakers provide true stereo reproduction and excellent sound clarity and tonal range. The tape segment of the unit accepts the popular eight-track cartridges. Insertion of the tape cartridge automatically shuts off the radio. Controls are provided for manual tuning, front-to-rear balance, volume, tone, and push-button radio selection. 5 x 10 push-button feature allows the five push-buttons to be preset to five AM and five FM stations. Includes a fixed length, stainless steel antenna.

An AM or an AM/FM stereo radio is also available.

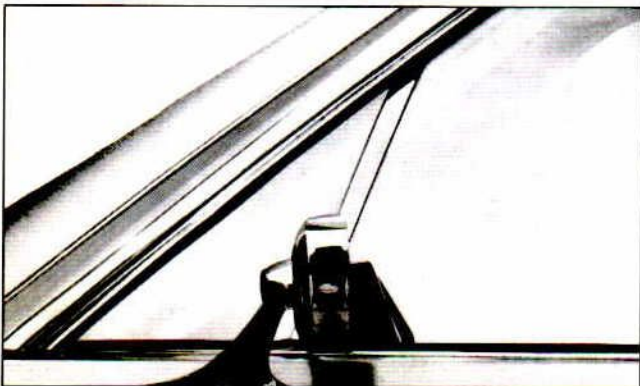

POWER MINI-VENT AND SIDE WINDOWS

This option is available on all four-door models, including station wagons. (Power side windows, without mini-vents, are available on all models.) The small, triangular-shaped mini-vent is at the front of the door glass and moves vertically. This design provides a practical venting arrangement without the air noise associated with a conventional pivoting vent window.

To operate the mini-vent, the driver or passenger activates the front power side window switch. The mini-vent lowers first and can be stopped in any position. When the vent is fully lowered and the switch is held in position, the main window lowers and can be stopped in any position. Power window controls are conveniently located on the armrest to allow the driver to adjust all windows as desired. Included is a lock-out switch feature which can be used to prevent occupants, other than the driver, from operating the windows. (Requires tinted glass and remote control LH mirror at extra cost.)

CONVENIENCE GROUP

Available on all models, the Convenience Group combines seven features for driver and passenger comfort and convenience: outside left-hand and right-hand remote control mirrors, automatic parking brake release, interval windshield wipers, color-keyed deluxe belts, vanity visor mirror and auxiliary ash tray in right front armrest. Also included is an electric deck-lid release for passenger cars or for station wagons, an electric-power tailgate lock. The Convenience Group is included with the Brougham and Squire Luxury Groups.



DELUXE BUMPER GROUP

This functional option, included with the Brougham and Squire Luxury Groups, is designed to reduce minor damage to bumpers. Front and rear vertical bumper guards are included. On station wagon models, rear bumper guards also feature an integrated rubber step, for more convenient third seat exit and entry. All models ordered with this option also include horizontal front and rear bumper rub strips. (Rear rub strips for wagons will not be available until later in the model year.)

FORD OPTIONS



SPLIT BENCH SEATS WITH MANUAL PASSENGER RECLINER

Available only on the LTD Brougham and standard with Country Squire Brougham, Brougham and Squire Luxury Groups, this luxury option provides the ultimate in seating comfort. The seats are individually adjustable with a fold-down center armrest for each seat. The passenger seat back has a recliner adjustable to any desired position. This option is available in cloth-and-vinyl or all-vinyl trim on passenger cars and all vinyl or DuraWeave on wagons.

FRONT CORNERING LAMPS

Available with all LTD models (including Country Squire), the cornering lamps are designed to light up the side when turning. The lamp casts a beam when activated with the turn signal lever and remains on until the turn signal lever returns to its center position.

AUTOMATIC SEAT BACK RELEASE

This option, available on all two door models, automatically releases both front seat-back latches when either door is opened to facilitate entry into the rear seat, especially when carrying a briefcase or packages. The latch release is triggered by a plunger-type switch located in the "A" pillar which activates a solenoid located in the seat back. A manual release is also provided in the event of an electrical failure or other malfunction. This option is standard with the LTD Brougham model.

POWER-OPERATED SUNROOF

A power-operated sunroof, located over the front compartment, is available on Ford hardtops and pillared hardtops with the optional vinyl roof. It provides the open-air advantages of a convertible with



the styling, quietness and security of a hardtop. Measuring approximately 39" x 21", the sunroof is powered by an electric motor, which is actuated by a fingertip control in the roof and slides back out of sight above the headliner. When closed, the sunroof matches the roofline and seals tightly in position, keeping the weather and noise outside.

METALLIC GLOW PAINT

Four optional "Metallic Glow" finishes are available for 1974; Tan Glow, Gold Glow, Green Glow and Ginger Glow. The illusion of extra depth is due to the control and size of the aluminum particles in the special paint formula. The clarity and transparency of the highly durable surface also contribute to the distinctive characteristics of this glamorous new finish.

INTERVAL WINDSHIELD WIPERS

In addition to the standard two-speed constant sweep wipers, this convenient feature permits adjustable pauses of two to ten seconds between sweeps. Ideal to help prevent the streaking and squeaking commonly experienced from road splatter and in light rain or snow. Interval windshield wipers are included in the Convenience Group.

FINGERTIP SPEED CONTROL

The fingertip speed control regulates the speed automatically and maintains a set speed at a desired level, until reset or turned off.

The controls are conveniently located in the spokes of a deluxe, two-spoke steering wheel. When in the "On" position, the speed control can be set to maintain any speed from 30 to 80 mph by attaining that speed and pressing the "Set" button on the right side of the steering wheel. The "Set" speed can be changed by rocking the "Set" button to accelerate or decelerate as indicated on the button.

The system is deactivated (1) by brake application, (2) if the car slows approximately 10 mph below the set speed, (3) by the speed control On/Off switch or (4) by the ignition switch. The system will not operate below 30 mph or above 80 mph. The speed control option includes the "rim-blow" steering wheel. A switch built into the inner rim of the steering wheel activates the horn when pressed at any point. A "rim-blow" deluxe, three-spoke steering wheel is available as a separate option.

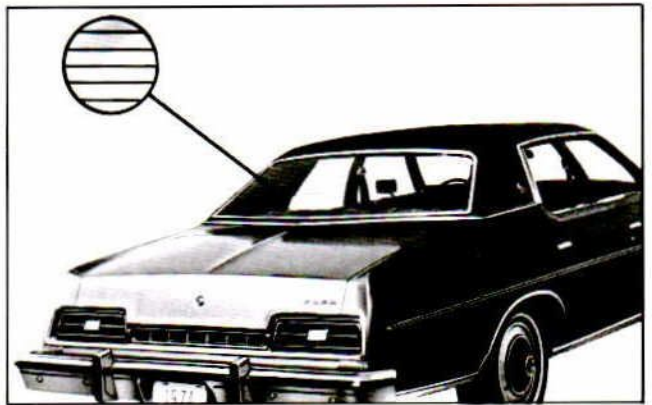

ELECTRIC REAR WINDOW DEFROSTER

This "Better Idea" helps keep the backlite frost-free and will melt snow and frost, and up to 1/8 inch of ice, in minutes. The heating unit consists of a silver-filled, ceramic, high-resistance printed electrical circuit, silk-screened onto the inside of the backlite. While visible as a series of 1/32-inch wide horizontal lines across the backlite, the unit does not interfere with the driver's rear vision due to wide spacing between lines.

The unit has a high wattage output per square inch of window surface, which helps defog the glass and melt frost and snow more quickly. An "On" and "Off" switch is integrated with the heater controls and a reminder light indicates when the unit is on. A 70-amp. alternator is also included.

FORD OPTIONS

"TRACTION-LOK" DIFFERENTIAL AXLE

The "Traction-Lok" system provides maximum accelerating power by locking the rear wheels together under high torque. This differential provides extra traction on ice, mud or snow. It offers better performance and increased life expectancy compared to the "Equalock," primarily due to a decrease in fixed load, and improved clutch and special gear design. See additional information in the Power Teams Section.



BROUGHAM LUXURY GROUP

This new luxury option is available on all LTD Brougham models. Included are split bench seats with manual passenger recliner in luxurious, crushed Velour cloth trim, unique door trim with beige velour inserts, door pull straps, rich 25-oz. cut-pile carpeting in the passenger compartment and 10 $\frac{1}{2}$ -oz. cut-pile carpeting in the luggage compartment, deluxe bumper group, cigar lighters in rear door armrests and increased sound-deadening materials. The Convenience Group is also included in the new Brougham Luxury Group options. See page B-21 for contents.

AUTOMATIC LOAD ADJUSTER

The automatic load adjuster is recommended for customers who haul heavy loads. It is designed to correct the car level attitude regardless of the load (up to rated capacity). The option consists of a vacuum-driven air pump, a leveling valve with time delay operation and an air shock-absorber system. When vehicle loads are increased to three or more passengers, or loads of approximately 450 pounds or more, the pump automatically increases air pressure to restore the car to design height. The time delay feature of the leveling valve prevents operation of the automatic load adjuster during temporary changes of load. This option now is also available with optional heavy-duty suspension.

ANTI-THEFT ALARM SYSTEM

The optional Anti-Theft Alarm System is a major deterrent to the theft of vehicle or vehicle contents. The system utilizes a Solid-State electronic device, and when armed senses any opening of doors or decklid/tailgate, then actuates the car's horn which will blow intermittently for five to seven minutes unless the system is disarmed. A switch attached to the front-door lock tumblers provides the method of arming and the electronic device provides the functions of sensing voltage differentials, activation, sounding the horn, timing, automatic shut-down and deactivation.

The system is armed by locking either front door with the key.

NOTE: The system must be disarmed before the trunk lid or doorgate can be opened or the alarm will be activated. Unlocking either front door with the proper key will disarm the alarm. Once the alarm has been triggered, the system can be deactivated by inserting the key in the door lock and turning to the unlock position or by inserting the key into the ignition and turning it to the "On" or "Accessory" position. The system will continue sounding the horn intermittently for five to seven minutes unless it is deactivated in this manner. The power for the alarm system is supplied by the battery. A locking hood release is included in the option to help prevent tampering with the battery. A spare tire lock is also included in the option to add additional protection against tire theft.

For customer convenience, there is a time delay of approximately ten seconds after arming until the alarm system is operational. This time delay allows sufficient time for all occupants to exit the vehicle. Decals are also included and may be affixed at the owner's discretion.

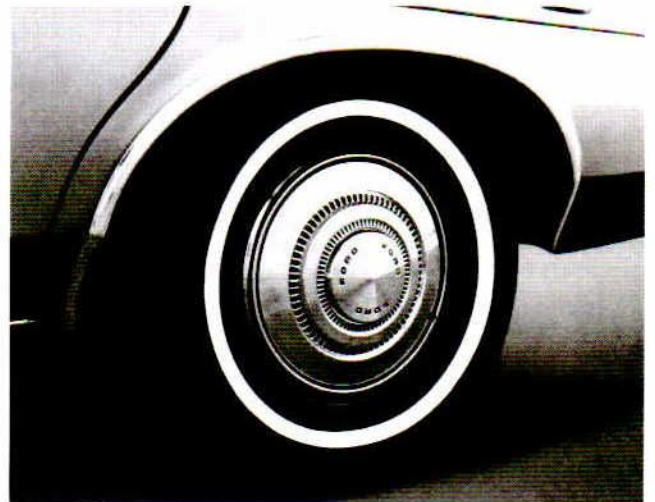

BASE WHEEL COVERS

These rust-resistant full wheel covers are standard on LTD Brougham and Country Squire models. They are optional on all other models.



DELUXE WHEEL COVER

This luxurious wheel cover option is available on all models for an added styling touch.

FORD OPTIONS (Cont'd)

LOAD-EQUALIZING TRAILER HITCH PLATFORM

This new option bolts to the frame just behind the rear axle. The platform, when used in conjunction with an equalizing trailer hitch, is designed to equalize the trailer tongue load between the towing vehicle's front and rear wheels—thereby eliminating rear end sag.

A Class II or Class III trailer towing package is required with this option.

TRAILER TOWING PACKAGES

Ford offers three trailer towing packages for 1974:

CLASS I (2000-lb. maximum trailer weight—200-lb. maximum tongue weight) includes trailer hitch with removable ball and

tongue and wiring harness.

CLASS II* (3500-lb. maximum trailer weight—500-lb. maximum tongue weight) includes heavy-duty suspension, extra cooling package, trailer towing identification plaque and wiring harness.

CLASS III* (7000-lb. maximum trailer weight—800-lb. maximum tongue weight) includes heavy-duty suspension, heavy-duty battery and alternator, transmission oil cooler, extra cooling package, 6½-inch wheel rims, trailer towing identification plaque, wiring harness, trailer towing frame, and high ratio axle. (High ratio axle NA California.)

NOTE: See trailer towing warranty statement on page 2.

*Requires 400 CID 2V or larger engine, J78 x 15 tires on sedans and LR78 x 15 tires on wagon models; at extra cost. 460 CID 4V recommended with Class III.

FORD OPTIONS AVAILABILITY

DESCRIPTION

APPEARANCE-PROTECTION EQUIPMENT

Alarm System, Anti-Theft (Includes alarm, lockable inside hood release, spare tire lock and decals.)

Protection Group (Includes door-edge guards, license plate frames, spare tire lock, lockable hood release and gas cap, and color-keyed front and rear floor mats with carpet inserts.)

Belts, Color-Keyed Deluxe Seat and Shoulder (Standard on LTD Brougham.)

Bumper Group, Deluxe (Includes front and rear bumper guards with rubber inserts and full-width horizontal rub strips)(rear rub strips are a running change on wagons). (Station wagon models also include an integrated rubber step in the rear bumper guard.) (Standard with Brougham and Squire Luxury Groups.)

Bumper Guards, Front (Includes rubber inserts.)

Bumper Guards, Rear (Includes rubber inserts.)

Cornering Lamps, Front (Available only on LTD, LTD Brougham, LTD Wagon and Country Squire models.)

Luggage Compartment Trim (Includes 10.5-oz. cut-pile carpeting and spare tire cover.) (Not available on station wagon models.) (Standard with Brougham Luxury Group.)

Moldings, Rocker Panel (Standard on LTD, LTD Brougham and LTD Wagon models.) (Not available on Country Squire model.)

Moldings, Vinyl Insert Bodyside (Standard on LTD and LTD Brougham and LTD Wagon models.)

Paint, Metallic Glow (Available in Tan Glow, Gold Glow, Green Glow, or Ginger Glow.)

Paint, Tu-Tone Roof (Includes bright hood rear moldings and belt moldings on Custom 500 4-Door pillared hardtop model.) (Not available on station wagon or LTD Brougham models.)

Paint Stripes, Dual Accent (Not available on Country Squire model.)

Roof, Vinyl (Includes cross-hatch grain on hardtop and pillared hardtop models; Odense grain on station wagon models.) (Bright hood rear molding and belt moldings included on Custom 500 and Ranch Wagon models.)

Wheel Covers (Standard on LTD Brougham and Country Squire models.)

Wheel Covers, Deluxe.

AUDIO EQUIPMENT

Radio, AM

Radio, AM/FM Stereo (Includes two front-door mounted speakers and dual rear-seat speakers.)

DESCRIPTION

Radio with Tape Player, AM/FM Stereo (Includes two front-door mounted speakers and dual rear-seat speakers.)

Speakers, Dual Rear Seat (Includes fader control.) (Standard with AM/FM stereo radio with or without tape player.) (Available only with AM radio.)

COMFORT/CONVENIENCE EQUIPMENT

Air Conditioner—SelectAire (Includes 55-ampere alternator.) (Tinted glass—complete recommended.)

Air Conditioner—SelectAire with Automatic Temperature Control (Includes 55-ampere alternator.) (Tinted glass—complete recommended.)

Cargo Area, Deluxe (Includes padded quarter trim panels with carpeting on lower portion, lockable side stowage compartment, and carpeted cargo area.) (Available only on station wagon models.) (Standard with Squire Luxury Group.)

Clock, Electric (Standard on LTD, LTD Brougham, LTD Wagon and Country Squire models.)

Convenience Group (Includes outside left-hand and right-hand remote control mirrors, electric trunk lid release (except station wagons), electric power tailgate lock (station wagons only), automatic parking brake release, interval windshield wipers, vanity visor mirror and auxiliary ash tray in right front armrest.) (Auxiliary ash tray in right front-armrest standard on LTD Brougham models or with Squire Brougham Option.)

Defogger, Rear Window (Not available on station wagon models or with electric rear window defroster.)

Defroster, Electric Rear Window (Includes tinted backlite glass and 70-ampere alternator.) (Not available with rear window defogger.)

Glass, Tinted—Complete (Recommended with air conditioner.)

Light Group (Includes instrument panel courtesy lights, parking brake warning light, luggage compartment light, cargo light on station wagons, glove compartment light, rear-door courtesy light switches, engine compartment light, dual beam map light and "headlights on" warning buzzer.) (Glove compartment light and luggage compartment or cargo light standard on LTD, LTD Wagon, Country Squire and LTD Brougham models.) (Rear-door courtesy light switches standard on LTD Brougham and with Squire Brougham, Squire Luxury Group options.) (Parking brake warning light deleted when this option is ordered in combination with Convenience Group or automatic parking brake release.)

FORD OPTIONS AVAILABILITY

DESCRIPTION

COMFORT/CONVENIENCE EQUIPMENT (Cont'd)

Lockable Side Stowage Compartment/Carpeted Cargo Area (Includes 1.8 cubic foot of extra storage space and color-keyed carpet.) (Standard with deluxe cargo area.) (Available only on station wagon models.)

Luggage Rack, Deluxe (Includes integral rear-window air deflector, simulated woodtone appliqué, and adjustable rear cross bar.) (Available only on station wagon models.)

Mirror, Outside Left-Hand Remote Control (Standard with Convenience Group.) (Required with power side windows or electric power door locks.)

Recreation Table (Includes magnetized checkers.) (Available only on station wagon models with dual-facing rear seats.)

Seat Back Release, Automatic (Available only on 2-door models.) (Standard on LTD Brougham.)

Seats, Dual-Facing Rear (Available only on wagon models.) (Country Squire models ordered with this option include LR78 BSW tires.)

Seats, Split Bench with Manual Passenger Recliner (Includes dual front-seat center armrests, and choice of cloth-and-vinyl or all-vinyl trim on passenger cars, all vinyl or DuraWeave vinyl on wagons.) (Standard with Squire Brougham Option, Brougham and Squire Luxury Groups.) (Available only on LTD Brougham models.)

Speed Control, Fingertip (Includes rimblow—deluxe two-spoke steering wheel.) (Not available with 351 CID 2V engine, rimblow—deluxe three-spoke steering wheel.)

Squire Brougham Option (Includes split bench seats with manual passenger recliner, Brougham trim scheme, cut-pile carpet (excluding cargo area), color-keyed deluxe seat and shoulder belts, auxiliary ash tray in right front armrest, front-door courtesy lights and rear-door courtesy light switches.) (Available only on LTD Wagon and Country Squire models.)

Steering Wheel Rim-Blow—Deluxe Three-Spoke (NA Fingertip Speed Control.)

Steering Wheel, Tilt

Sunroof, Power-Operated (Not available on station wagon models.) (Requires vinyl roof at extra cost except on LTD Brougham.)

Tailgate Window Washer (Available only on station wagon models.) (Standard with Squire Luxury Group.)

Brougham Luxury Group (Includes split bench seats with manual passenger recliner, unique sew style in crushed velour cloth, unique door trim with crushed velour inserts, door pull straps, 25-oz. cut-pile floor carpeting, luggage compartment trim, Convenience Group, deluxe bumper group, cigar lighters in rear door armrests and increased sound packaging.) (Available only on LTD Brougham models.)

Squire Luxury Group (Includes split bench seats, with manual passenger recliner, unique new style in tan Corinthian-grain, super-soft vinyl with horseshoe-shaped saddle accent stripe, unique door trim with tan Corinthian-grain, super-soft vinyl inserts, 25-oz. cut-pile floor carpeting, deluxe cargo area, color-keyed, deluxe seat belts, Convenience Group, tailgate window washer, deluxe bumper group, cigar lighters in rear-door armrests, rear-door courtesy lamp switches and increased sound-packaging.) (Available only on LTD Wagon and Country Squire models.) (Not available with DuraWeave knit vinyl trim.)

Trim, Vinyl Seat (Standard on station wagon models.)

Trim, DuraWeave knit vinyl (Available only on LTD Wagon and Country Squire models with standard bench seat or split bench) (Squire Brougham option). (NA with Squire Luxury Group.)

DESCRIPTION

ENGINES

400 CID 2V 8-Cylinder (Includes 68-ampere heavy-duty battery.) (Standard on Country Squire and LTD Wagon models.)

460 CID 4V 8-Cylinder (Includes 80-ampere heavy-duty battery.)

POWER ASSISTS

Power Door Locks, Electric (Requires outside, left-hand, remote control mirror at extra cost.) (Station wagon models include tailgate power door lock.)

Power Seat—6-Way Driver Only (Available only on LTD Brougham models and with Squire Brougham Option, Brougham Luxury Group or Squire Luxury Group.) (Requires split bench seats with manual passenger recliner at extra cost on LTD Brougham models.)

Power Seat—6-Way Full-Width (Includes bright side shields.) (Not available with split bench seats.)

Power Side Windows (Require outside, left-hand, remote control mirror at extra cost.)

Power Mini-Vent and Side Windows (Not available on 2-door models.) (Requires tinted glass—complete and outside, left-hand, remote control mirror at extra cost.)

TRAILER TOWING/SPECIAL AND HEAVY-DUTY EQUIPMENT

Axle, Optional Ratio

Axle, Traction-Lok Differential

Battery, Heavy-Duty—80-Ampere (Standard with 460 CID 4V engine, Trailer Towing Package—Class III.)

Load-Adjuster, Automatic (Recommended for models hauling heavy loads.) (NA with Class III trailer towing or load-equalizing trailer hitch platform.)

Suspension, Heavy-Duty (Includes heavy-duty springs and shock absorbers.) (Standard with Class II and III Trailer Towing Packages.)

Trailer Towing Package—Class I (Includes trailer hitch with removable ball and tongue, and wiring harness.)

Trailer Towing Package—Class II (Includes heavy-duty suspension, extra-cooling package, trailer towing plaque and wiring harness.) (Requires 400 CID 2V or larger engine, J78 tires on sedans and LR78 tires on station wagon models at extra cost.)

Trailer Towing Package—Class III (Includes heavy-duty suspension, heavy-duty battery, heavy-duty alternator, transmission oil cooler, extra-cooling package, 6½-inch wheel rims, trailer towing plaque, wiring harness, trailer towing frame and high ratio axle.) (High ratio axle NA California.) (Requires 400 CID 2V (460 recommended) engine, and J78 tires on sedans and LR78 tires on station wagon models.)

Load-Equalizing Trailer Hitch Platform (Requires Trailer Towing Package Class II or III.) (NA with automatic load-adjuster.)

TIRES

G78 x 15 bias-belted WSW

H78 x 15 bias-belted BSW

H78 x 15 bias-belted WSW

J78 x 15 bias-belted BSW

J78 x 15 bias-belted WSW

HR78 x 15 steel-belted radial ply BSW

HR78 x 15 steel-belted radial ply WSW

JR78 x 15 steel-belted radial ply BSW

JR78 x 15 steel-belted radial ply WSW

LR78 x 15 steel-belted radial ply BSW

LR78 x 15 steel-belted radial ply WSW

FORD GENERAL SPECIFICATIONS

ENGINE/AXLE RATIO SELECTIONS

ENGINE	REAR AXLE RATIOS		
	SelectShift Cruise-O-Matic		
	Standard	Optional	Traction-Lok
351 CID 2V V-8	2.75 (w) (b) 3.07 (c)	3.25 (b)	2.75 (b) 3.25 (b)
400 CID 2V V-8	2.75 (a)	3.25 (a)	2.75 (a) 3.25 (a)
460 CID 4V V-8	2.75 (a)	3.25 (a)	2.75 (a) 3.25 (a)

Air Conditioning available with either ratio

- (a) 3.00 Standard in California (c)—Cleveland
 (b) 3.07 Standard in California (w)—Windsor

TIRES—STANDARD AVAILABILITY

MODEL AND ENGINE APPLICATION	351 CID 2V 8-CYLINDER	400 CID 2V 8-CYLINDER	460 CID 4V 8-CYLINDER
CUSTOM 500 4-Door Pillared Hardtop Ranch Wagon—Six-Passenger	G78 (c) J78	G78 (a) J78	H78 J78
GALAXIE 500 2-Door Hardtop 4-Door Pillared Hardtop 4-Door Hardtop Country Sedan—Six-Passenger	G78 (c) G78 (c) G78 (a) J78	G78 (a) G78 (a) G78 (a) J78	H78 H78 H78 J78
FORD LTD 2-Door Hardtop 4-Door Pillared Hardtop 4-Door Hardtop LTD Wagon Country Squire—Six Passenger	HR78 HR78 HR78 N/A N/A	HR78 HR78 HR78 JR78 JR78 (b)	HR78 HR78 HR78 JR78 JR78 (b)
FORD LTD BROUGHAM 2-Door Hardtop 4-Door Pillared Hardtop 4-Door Hardtop	HR78 HR78 HR78	HR78 HR78 HR78	HR78 HR78 HR78

- (a) H78 BSW standard on models with air conditioner and/or sunroof.
 (b) LR78 BSW standard on models with dual-facing rear seats.
 (c) H78 BSW standard on models with sunroof.

FORD GENERAL SPECIFICATIONS

BRAKE SPECIFICATIONS

FRONT DISC/ REAR DRUM	ALL MODELS
Brake Rotor Diameter (Disc).....	11.72
Outer Working Surface Diameter.....	11.72
Inner Working Surface Diameter.....	7.78
Front Swept Area*.....	217.3
Drum Diameter/Width.....	11.03 x 2.25
Rear Swept Area*.....	155.9
Total Front and Rear Swept Area*.....	373.2
Lining Material.....	Molded Asbestos
Lining Attachment.....	Riveted
Parking Brake—Type.....	Mechanical Actuation of Rear Brake

STEERING SPECIFICATIONS

Linkage Type.....	Parallelogram with Cross Link and Idler Arm
Gear Type Power.....	Recirculating Ball and Nut
Overall Steering Ratio Power.....	22.2:1
Steering Wheel Turns (Lock-to-Lock) Power.....	03.99
Turning Diameter (Curb-to-Curb).....	42 Feet
Steering Wheel Diameter.....	15 x 15½

WHEEL SPECIFICATIONS

Type.....	Stamped-Steel Disc
Number of Studs.....	5
Diameter and Rim Size (inches)	
Passenger.....	15 x 5
Station Wagon.....	15 x 6.5

CURB WEIGHTS

MODEL	CURB WEIGHT
TWO-DOOR HARDTOPS	
Galaxie 500.....	4300
LTD.....	4365
LTD Brougham.....	4390
FOUR-DOOR PILLARED HARDTOPS	
Custom 500.....	4300
Galaxie 500.....	4340
LTD.....	4405
LTD Brougham.....	4420
FOUR-DOOR HARDTOPS	
Galaxie 500.....	4360
LTD.....	4430
LTD Brougham.....	4450
STATION WAGONS	
Custom 500 Ranch Wagon (6-Passenger).....	4770
Custom 500 Ranch Wagon DFRS*.....	4820
Country Sedan (6-Passenger).....	4805
Country Sedan DFRS*.....	4855
LTD Wagon (6-Passenger).....	4820**
LTD Wagon DFRS*.....	4870**
Country Squire (6-Passenger).....	4890**
Country Squire DFRS*.....	4935**

*Optional Dual-Facing Rear Seats

NOTE: All weights except Country Squire and LTD Wagon include 351 CID Engine.

**Country Squire and LTD Wagon include 400 CID Engine

FORD GENERAL SPECIFICATIONS

BODY DIMENSIONS

All dimensions in inches unless otherwise noted	4-Door Pillared Hardtops			2-Door Hardtops		4-Door Hardtops		Station Wagons			
	Custom 500	Galaxie 500	LTD & LTD Brougham	Galaxie 500	LTD & LTD Brougham	Galaxie 500	LTD & LTD Brougham	Ranch Wagons	Ctry. Sed.	LTD Wagon	Ctry. Squire
GENERAL											
Wheelbase	121	121	121	121	121	121	121	121	121	121	121
Tread—Front	64.2	64.2	64.2	64.2	64.2	64.2	64.2	64.1	64.1	64.1	64.1
—Rear	64.4	64.4	64.4	64.4	64.4	64.4	64.4	64.3	64.3	64.3	64.3
Height—Overall	54.9	54.9	54.9	53.5	53.5	54.3	54.3	57.1	57.1	57.1	56.5
Length—Overall	222.5	222.5	222.5	222.5	222.5	222.5	222.5	225.2	225.2	225.2	225.2
Width—Overall	79.5	79.5	79.5	79.5	79.5	79.5	79.5	79.6	79.6	79.6	79.6
Width—At Center Pillar	78.1	78.1	78.1	77.9	77.9	78.1	78.1	78.1	78.1	78.1	78.1
FRONT DOOR ENTRANCE ROOM											
Foot Clearance	17.8	17.8	17.8	17.6	17.6	17.6	17.6	17.8	17.8	17.8	17.8
Entrance Height (seat to windcord)	30.8	30.8	30.8	30.1	30.1	30.1	30.1	30.8	30.8	30.8	30.8
REAR DOOR ENTRANCE ROOM											
Foot Clearance	13.6	13.6	13.6	—	—	13.6	13.6	14.8	14.8	14.8	14.8
Entrance Height (seat to windcord)	30.4	30.4	30.4	—	—	29.5	29.5	30.5	30.5	30.5	30.5
FRONT SEAT ROOM											
Head Room (Effective)	38.2	38.2	38.2	37.3	37.3	38.2	38.2	38.7	38.7	38.7	38.7
Maximum Leg Room to Accelerator	41.5	41.5	41.5	41.5	41.5	41.5	41.5	41.5	41.5	41.5	41.5
Hip Room	61.6	61.6	61.6	61.6	61.6	61.6	61.6	61.6	61.6	61.6	61.6
Shoulder Room	61.5	61.5	61.5	61.5	61.5	61.5	61.5	61.5	61.5	61.5	61.5
Cushion Height (from floor to crest of front)	10.8	10.8	10.8	11.3	11.3	11.3	11.3	10.8	10.8	10.8	10.8
Cushion Depth	15.0	15.0	15.0	14.8	14.8	14.8	14.8	15.0	15.0	15.0	15.0
Steering Wheel (to thigh clearance)	4.1	4.1	4.1	3.7	3.7	3.7	3.7	4.1	4.1	4.1	4.1
REAR SEAT (OR WAGON SECOND SEAT) ROOM											
Head Room (Effective)	37.3	37.3	37.3	36.3	36.3	37.3	37.3	39.1	39.1	39.1	39.1
Minimum Effective Leg Room	38.4	38.4	38.4	35.5	35.5	38.4	38.4	37.1	37.1	37.1	37.1
Hip Room	61.7	61.7	61.7	60.8	60.8	61.7	61.7	61.7	61.7	61.7	61.7
Shoulder Room	61.4	61.4	61.4	60.6	60.6	61.4	61.4	61.4	61.4	61.4	61.4
Cushion Height (from floor to crest at front)	13.0	13.0	13.0	13.1	13.1	13.0	13.0	12.8	12.8	12.8	12.8
Cushion Depth	14.8	14.8	14.8	13.7	13.7	14.4	14.4	13.4	13.4	13.4	13.4
3RD SEAT ROOM (DFRS OPTION)											
Head Room (Effective)	—	—	—	—	—	—	—	35.5	35.5	35.9	35.9
Leg Room (Effective)	—	—	—	—	—	—	—	32.6	32.6	32.6	32.6
LUGGAGE COMPARTMENT											
Usable Luggage Capacity (cu. ft.)	19.0	19.0	19.0	19.0	19.0	19.0	19.0	—	—	—	—
CARGO COMPARTMENT											
Cargo Volume (cu. ft.)	—	—	—	—	—	—	—	94.6*	94.6*	94.6*	94.6*
Maximum Floor Length (tailgate open)	—	—	—	—	—	—	—	113.9	113.9	113.9	113.9
Minimum Load Floor Length (tailgate closed)	—	—	—	—	—	—	—	92.4	92.4	92.4	92.4
Maximum Rear Opening Width	—	—	—	—	—	—	—	51.1	51.1	51.1	51.1
Rear Opening Height	—	—	—	—	—	—	—	29.0	29.0	29.0	29.0
Maximum Floor Width (between wheelhousings)	—	—	—	—	—	—	—	48.7	48.7	48.7	48.7
Maximum Floor Width	—	—	—	—	—	—	—	61.6	61.6	61.6	61.6
GLASS AREA (sq. inches)											
Side Glass Exposed Surface Area	1541.3	1541.3	1541.3	1311.6	1311.6	1610.8	1610.8	2970.6	2970.6	2970.6	2970.6
Windshield Glass Exposed Surface Area	1365.0	1365.0	1365.0	1363.4	1363.4	1339.1	1339.1	1365.0	1365.0	1365.0	1365.0
Backlite Glass Exposed Surface Area	930.7	930.7	930.7	1115	1115	850	950	688.8	688.8	688.8	688.8
Total Glass Exposed Surface Area	3837.0	3837.0	3837.0	3790.0	3790.0	3799.9	3799.9	5024.4	5024.4	5025.4	5025.4

*Additional 9.1 cu. ft. on 6-Passenger Wagons, and 5.4 cu. ft. with dual-facing rear seat for storage under load floor. (1.2-cu. ft. optional lockable stowage in left rear quarter.)

FORD COLOR AND TRIM SELECTIONS

Charts shown reflect the color and trim combinations. Exterior colors and codes are in the first chart and the trim combinations follow. Colors and codes referenced are the same as those shown in your color and Trim Book.

EXTERIOR COLORS AND CODES			
INTERIOR TRIM		EXTERIOR COLOR AVAILABILITY CODES	
COLOR	CODE	COLOR	CODE
Black	1C	Med. Brown Met.	5H
White	9A	Saddle Bronze Met.	5T
Candyapple Red	2E	Med. Copper Met.	5M
Dark Blue Met.	3G	Medium Ivy Yellow	6N
Medium Blue Met.	3D	Green Glow	4T*
Light Blue	3B	Ginger Glow	5J*
Dark Green Met.	4Q	Gold Glow	6F*
Pastel Lime	4A	Tan Glow	5U*

*Extra Cost Metallic Glow Paint.

CUSTOM 500—STANDARD			
CLOTH-AND-VINYL			
INTERIOR TRIM		EXTERIOR COLOR AVAILABILITY CODES	
COLOR	CODE	EXTERIOR COLOR AVAILABILITY CODES	
Med. Blue	AB	9A, 3B, 3D, 3G	
Med. Green	AR	9A, 4A, 4Q, 4T, 6N	
Lt. Beige	AT	9A, 1C, 2E, 4Q, 5H, 5J, 5M, 5T	

CUSTOM 500 OPTION RANCH WAGON STANDARD			
ALL-VINYL			
INTERIOR TRIM		EXTERIOR COLOR AVAILABILITY CODES	
COLOR	CODE	EXTERIOR COLOR AVAILABILITY CODES	
Med. Blue	BB	9A, 3B, 3D, 3G	
Med. Green	BR	9A, 4A, 4Q, 4T	
Lt. Beige (Passenger Car)	BT	9A, 1C, 2E, 4Q, 5H, 5J, 5M, 5T	
Tan (Ranch Wagon)	BT	9A, 1C, 2E, 4Q, 5H, 5J, 5M 5T, 5U	

GALAXIE 500—STANDARD			
CLOTH-AND-VINYL			
INTERIOR TRIM		EXTERIOR COLOR AVAILABILITY CODES	
COLOR	CODE	EXTERIOR COLOR AVAILABILITY CODES	
Black	DA	9A, 1C, 2E, 4A, 4Q, 4T, 5M, 6F, 6N	
Med. Blue	DB	9A, 3B, 3D, 3G	
Med. Green	DR	9A, 4A, 4Q, 4T, 6N	
Lt. Beige	DT	9A, 1C, 2E, 4Q, 5H, 5J, 5M, 5T	
Med. Saddle	DZ	9A, 5H, 5J, 5M, 5T, 5U, 6F	

COUNTRY SEDAN—STANDARD GALAXIE 500—OPTION			
ALL-VINYL			
INTERIOR TRIM		EXTERIOR COLOR AVAILABILITY CODES	
COLOR	CODE	EXTERIOR COLOR AVAILABILITY CODES	
Black	EA	9A, 1C, 2E, 4A, 4Q, 4T, 5M, 6F, 6N	
Med. Blue	EB	9A, 3B, 3D, 3G	
Med. Green	ER	9A, 4A, 4Q, 4T, 6N	
Lt. Beige	ET	9A, 1C, 2E, 4Q, 5H, 5J, 5M, 5T	
Med. Saddle	EZ	9A, 5H, 5J, 5M, 5T, 5U, 6F	

LTD STANDARD			
CLOTH-AND-VINYL			
INTERIOR TRIM		EXTERIOR COLOR AVAILABILITY CODES	
COLOR	CODE	EXTERIOR COLOR AVAILABILITY CODES	
Black	GA	9A, 1C, 2E, 4A, 4Q, 4T, 5M, 6F, 6N	
Med. Blue	GB	9A, 3B, 3D, 3G	
Med. Green	GR	9A, 4A, 4Q, 4T, 6N	
Lt. Beige	GT	9A, 1C, 2E, 4Q, 5H, 5J, 5M, 5T	
Med. Saddle	GZ	9A, 5H, 5J, 5M, 5T, 5U, 6F	

COUNTRY SQUIRE, LTD WAGON—STANDARD LTD—OPTION			
ALL-VINYL			
INTERIOR TRIM		EXTERIOR COLOR AVAILABILITY CODES	
COLOR	CODE	EXTERIOR COLOR AVAILABILITY CODES	
Black	FA	9A, 1C, 2E, 4A, 4Q, 4T, 5M, 6F, 6N	
Med. Blue	FB	9A, 3B, 3D, 3G	
Med. Green	FR	9A, 4A, 4Q, 4T	
Lt. Beige (LTD)	FT	9A, 1C, 2E, 4Q, 5H, 5J, 5M, 5T	
Lt. Tan (Country Squire LTD Wagon)	FT	9A, 1C, 2E, 4Q, 5H, 5J, 5M, 5T, 5U	
Med. Saddle	FZ	9A, 5H, 5J, 5M, 5T, 5U, 6F	
White with Black*	FW	9A, 1C, 2E	
White with Blue*	FQ	9A, 3B, 3D, 3G	
White with Green*	F5	9A, 4A, 4Q, 4T	
White with Saddle*	F8	9A, 5H, 5J, 5M, 5T, 5U, 6F	
White with Gold*	F9	9A, 6F, 6N	

*Available on LTD 2-door hardtop only.

LTD BROUGHAM—STANDARD			
FLIGHT BENCH CLOTH-AND-VINYL			
INTERIOR TRIM		EXTERIOR COLOR AVAILABILITY CODES	
COLOR	CODE	EXTERIOR COLOR AVAILABILITY CODES	
Black	HA	9A, 1C, 2E, 4A, 4Q, 4T, 5M, 6F, 6N	
Med. Blue	HB	9A, 3B, 3D, 3G	
Med. Green	HR	9A, 4A, 4Q, 4T, 6N	
Lt. Beige	HT	9A, 1C, 2E, 4Q, 5H, 5J, 5M, 5T	
Lt. Gold	HY	9A, 1C, 4A, 6F, 6N	
Med. Saddle	HZ	9A, 5H, 5J, 5M, 5T, 5U, 6F	

LTD BROUGHAM—OPTION			
SPLIT BENCH CLOTH-AND-VINYL			
INTERIOR TRIM		EXTERIOR COLOR AVAILABILITY CODES	
COLOR	CODE	EXTERIOR COLOR AVAILABILITY CODES	
Black	JA	9A, 1C, 2E, 4A, 4Q, 4T, 5M, 6F, 6N	
Med. Blue	JB	9A, 3B, 3D, 3G	
Med. Green	JR	9A, 4A, 4Q, 4T, 6N	
Lt. Beige	JT	9A, 1C, 2E, 4Q, 5H, 5J, 5M, 5T	
Lt. Gold	JY	9A, 1C, 4A, 6F, 6N	
Med. Saddle	JZ	9A, 5H, 5J, 5M, 5T, 5U, 6F	

SQUIRE BROUGHAM OPTION			
SPLIT BENCH DURAWEAWE KNIT VINYL			
INTERIOR TRIM		EXTERIOR COLOR AVAILABILITY CODES	
COLOR	CODE	EXTERIOR COLOR AVAILABILITY CODES	
Med. Blue	LB	9A, 3B, 3D, 3G	
Med. Green	LR	9A, 4A, 4Q, 4T, 6N	
Med. Saddle	LZ	9A, 5H, 5J, 5M, 5T, 5U, 6F	

FORD COLOR AND TRIM SELECTIONS

SQUIRE LUXURY GROUP

ALL-VINYL SPLIT BENCH

INTERIOR TRIM		EXTERIOR COLOR AVAILABILITY CODES
COLOR	CODE	
Light Tan	MU	9A, 1C, 2E, 3G, 4Q, 5H, 5J, 5M, 5T, 5U

SQUIRE BROUGHAM—OPTION LTD BROUGHAM—OPTION

ALL-VINYL SPLIT BENCH

INTERIOR TRIM		EXTERIOR COLOR AVAILABILITY CODES
COLOR	CODE	
Med. Blue	KB	9A, 3B, 3D, 3G
Med. Green	KR	9A, 4A, 4Q, 4T, 6N
Lt. Tan	KU	9A, 1C, 2E, 4Q, 5H, 5J, 5M, 5T, 5U
Med. Saddle	KZ	9A, 5H, 5J, 5M, 5T, 5U, 6F
White with Black*	KW	9A, 1C, 2E
White with Blue*	KQ	9A, 3B, 3D, 3G
White with Green*	K5	9A, 4A, 4Q, 4T
White with Saddle*	K8	9A, 5H, 5J, 5M, 5T, 5U, 6F
White with Gold*	K9	9A, 6F, 6N

*Available on LTD 2-door hardtop only.

BROUGHAM LUXURY GROUP

VELOUR CLOTH-AND-VINYL

INTERIOR TRIM		EXTERIOR COLOR AVAILABILITY CODES
COLOR	CODE	
Med. Beige	QT	9A, 1C, 2E, 4Q, 5H, 5J, 5M, 5T

COUNTRY SQUIRE OPTION

BENCH SEAT DURAWEAWE KNIT VINYL

INTERIOR TRIM		EXTERIOR COLOR AVAILABILITY CODES
COLOR	CODE	
Med. Blue	NB	9A, 3B, 3D, 3G
Med. Green	NR	9A, 4H, 4T, 4Q, 6N
Med. Saddle	NZ	9A, 5H, 5J, 5M, 5T, 5U, 6F

VINYL ROOF AVAILABILITY ALL MODELS LESS WAGONS

STANDARD LTD BROUGHAM

ROOF COLOR	CODE	EXTERIOR COLOR AVAILABILITY CODES
Black	A	9A, 1C, 2E, 4A, 4Q, 4T, 5M, 6F, 6N
White	W	All
Blue	B	9A, 3B, 3D, 3G
Green	R	9A, 4A, 4Q, 4T, 6N
Brown	T	9A, 5H, 5J, 5M, 5T, 5U, 6F
Beige	U	9A, 1C, 2E, 4Q, 5H, 5J, 5M, 5T, 5U
Gold	Y	9A, 1C, 4A, 6F, 6N

VINYL ROOF AVAILABILITY

STATION WAGONS

ROOF COLOR	CODE	EXTERIOR COLOR AVAILABILITY CODES
Black	A	9A, 1C, 2E, 4A, 4Q, 4T, 5M, 6F, 6N
White	W	All
Blue	B	9A, 3B, 3D, 3G
Green	R	9A, 4A, 4Q, 4T
Brown	T	9A, 1C*, 5H, 5J, 5M, 5T, 5U, 6F
Tan	U	9A, 1C, 5J, 5M, 5T, 5U, 2E, 4Q*

*Squire only.

- NOTE: Exterior and interior color combinations shown as "available" have been established as most attractive to the average customer. Orders for combinations not shown may be submitted, provided the original order carries a notation stating the exterior and interior selection has been verified and is definitely desired. This procedure does not apply to orders specifying two-tone paint combinations or vinyl roof colors.